



**INDOOR**  
*Catalog*

# WHAT'S INSIDE

## INDUSTRIAL

### LINEAR HIGH BAY

- 6 SELECTION GUIDE
- 8 EDV
- 10 EVT
- 12 GH
- 13 PHB-TC

### ROUND HIGH BAY & LOW BAY

- 15 SELECTION GUIDE
- 16 RB3
- 18 UFO-LB

### HAZARDOUS

- 21 SELECTION GUIDE
- 22 HZV
- 23 HZB

### VAPOR TIGHT

- 24 SELECTION GUIDE
- 26 WTZ
- 28 WTX
- 29 VVT
- 30 BL
- 31 RB3

### VAPOR TIGHT KITS

- 33 SELECTION GUIDE
- 34 VTR
- 35 BL



# COMMERCIAL

## TROFFERS

- 1 TITLE PAGE
- 2 SELECTION GUIDE
- 3 VOLA
- 4 FLT
- 5 VAT
- 6 PAN
- 7 VPAN

## TROFFER KITS

- 1 TITLE PAGE
- 2 SELECTION GUIDE
- 3 LANCE
- 4 VLN
- 5 FLTR
- 6 RTR

## STRIPS

- 1 TITLE PAGE
- 2 SELECTION GUIDE
- 3 DIS
- 4 QL
- 5 FZ

## STRIPS (CONTD.)

- 6 VS
- 7 SS
- 8 FX

## STRIP KITS

- 1 TITLE PAGE
- 2 SELECTION GUIDE
- 3 RZ
- 4 RX

## WRAPS

- 1 TITLE PAGE
- 2 SELECTION GUIDE
- 3 SQ & SQ-WB
- 4 FNW & FWW
- 5 FWS

## TLED PRODUCTS

- 1 TITLE PAGE
- 2 FST TLED
- 3 FNW & FWW TLED
- 4 RSB
- 5 RST
- 6 RTB
- 7 RTR





*INDUS*



# TRIAL





EVEREST HIGH BAY (EVT)	GRID FRAME HIGH BAY (GH)	PREMIUM HIGH BAY TENNIS COURT (PHB-TC)
✓	✓	✓
✓	✓	✓
✓	✓	✓
✓	✓	✓
✓	✓	✓
✓	✓	✓
✓		✓
✓		✓
	✓	
	✓	
12,000 - 56,000	12,000 - 26,000	65,000 - 91,000
152 LPW	158 LPW	137 LPW
>80	>80	>80
40, 50	30, 35, 40, 50	30, 35, 40, 50
Wide & Narrow	Wide	Indirect
120-277V - Opt. 347-480V	120-277V - Opt. 347-480V	120-277V - Opt. 347-480V
2FT, 3FT & 4FT	2x2 & 2x4	4FT
Linear	Linear	Linear
Frosted Acrylic & Polycarbonate	Frosted Acrylic & Clear Polycarbonate	Clear Polycarbonate
>100K	>100K	>100K
-40°F - 122°F	-40°F - 125°F	-40°F - 115°F
✓	✓	✓
Damp, IP5X	Damp	Damp
OPTIONAL	✓	✓
Premium	Premium	Standard
✓		✓
✓		✓
✓		✓
✓		✓
✓		✓
✓		✓
✓		✓
✓		✓
✓	✓	

# ENDEAVOUR HIGH BAY

## FEATURES

- Sleek curved polycarbonate injection molded end caps
- Aluminum body with steel channel for added rigidity
- Toolless hinged driver access
- Wide and narrow distributions
- Impact resistant and IP5X rated lens options:
  - Frosted acrylic (FRL)
  - Frosted polycarbonate (PFL) IK10 impact rated
- V-Clips for dual point chain or cable hanging (standard)
- Advanced and basic controls options
- -40°F-131°F ambient temperature range
- Uplight options
- >80 color rendering index (CRI)
- Calculated L70 >100,000 hours
- 0-10V dimmable driver (100%-10%)
- 120-277V universal voltage and 347-480V high voltage via step down transformer



## DISTRIBUTION TYPES

Wide and narrow distribution types are available for all lumen packages.



WIDE



NARROW

## UPLIGHT

Offers an additional layer of lighting to optimize full room illumination with dedicated driver and LED boards in an encapsulated IP5X chamber.

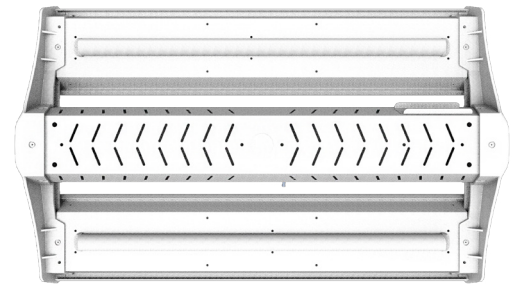

## SUITABLE APPLICATIONS

- Gymnasiums
- Warehouses
- Manufacturing Plants
- Distribution Centers



## LED SYSTEMS INFO

PART NUMBER	LUMENS	WATTS	LM/W	REPLACES
EDV-8L-U-40-FRL	7,527 lm	51W	149 lm/W	100W MH, 4T8
EDV-12L-U-40-FRL	11,593 lm	82 W	141 lm/W	175W MH, 2T5HO
EDV-15L-U-40-FRL	14,946 lm	104W	143 lm/W	200W MH, 6T8
EDV-18L-U-40-FRL	18,668 lm	131W	142 lm/W	250W MH, 4T5HO
EDV-24L-U-40-FRL	22,350 lm	163W	138 lm/W	400W MH, 6T5HO
EDV-30L-U-40-FRL	28,751 lm	205W	141 lm/W	575W MH, 10T8
EDV-36L-U-40-FRL	33,040 lm	245W	135 lm/W	750W MH, 8T5HO
EDV-48L-U-40-FRL	44,053 lm	327W	135 lm/W	1000W MH, 10T5HO
EDV-60L-U-40-FRL	59,297 lm	409W	145 lm/W	1000W MH, 12T5HO



# ENDEAVOUR

LINEAR HIGH BAY  
EDV

## LUMENS

8,000 - 65,000

## EFFICACY

Up to 166 lm/W

## CCT



## TOOLLESS DRIVER DOOR

## CONSTRUCTION

Aluminum body with steel channel for added rigidity

## LENS OPTIONS

- No Lens
- Frosted Acrylic
- Frosted Polycarbonate

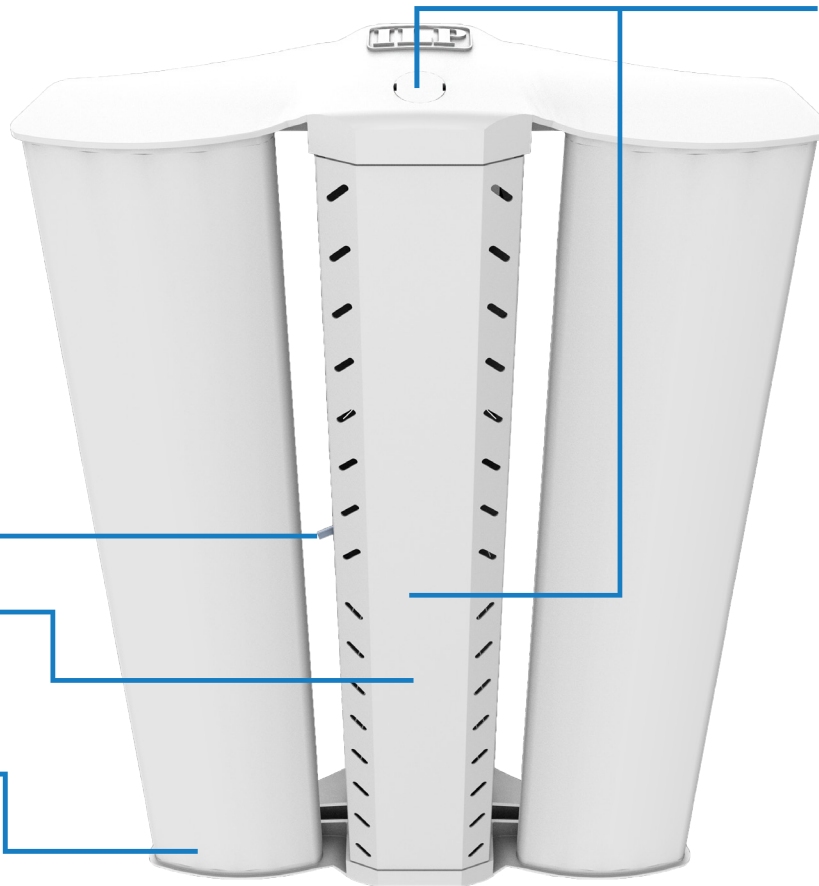

## CONTROLS

- **ADVANCED**
  - EasySense
  - Enlighted
  - Legrand
- **BASIC**
  - On/Off
  - Dimming
  - Daylight Harvesting

## MOUNTING

- Cable
- Hook
- Pendant
- Surface

## EMERGENCY

- 25W Battery Backups
- Generator Transfer Device

## ACCESSORIES

- Cords
- Modular Quick Disconnect Cord
- Wire Cage
- 347V - 480V

## ORDERING GUIDE

\*Options & Accessories are not shown. Please see the cut sheet on our website at [ilp-inc.com](http://ilp-inc.com) or scan the QR code below.

SERIES	LUMENS		DRIVER	CCT	LENS OPTIONS		DISTRIBUTION		UPLIGHT		FINISH	
EDV	8L	30L	U 120-277V	50	(BLANK)	No Lens	(BLANK)	Wide	(BLANK)	No Uplight	(BLANK)	White
Endeavour	12L	36L		40	FRL	Frosted Acrylic	ND	Narrow	UP/2L	2000lm Uplight	BLK	Black
	15L	48L		35	PFL	Frosted			UP/4L	4000lm Uplight		
	18L	60L		30		Polycarbonate						
	24L											



For more helpful information

# SCAN ME

Gain access to our flyer, promotional page, video, and more by scanning the product's QR code.

# EVEREST HIGH BAY

## FEATURES

- Versatile 2', 3', and 4' housing delivering 12,000 – 56,000 lumens
- Slim profile post painted steel housing for maximum rigidity
- Toolless hinged driver access
- Wide and narrow distributions
- Impact resistant and IP5X rated lens options:
  - Frosted acrylic (FRL)
  - Clear polycarbonate (PCL)
- V-Clips for dual point chain or cable hanging (standard)
- Advanced and basic controls options
- -4°F-122°F ambient temperature range
- 4000K-5000K CCT
- >80 color rendering index (CRI)
- Calculated L70 >100,000 hours
- 0-10V dimmable driver (100%-10%)
- 120-277V universal voltage and 347-480V high voltage via step down transformer



## SUITABLE APPLICATIONS

- Warehouses
- Distribution Centers
- Gymnasiums
- Manufacturing Plants



## NARROW DISTRIBUTION OPTIC

Strategically designed, the snap-on narrow distribution optic is installable in the factory or in the field - optimizing the installation process without the use of tools or additional hardware.



## MOUNTING OPTIONS

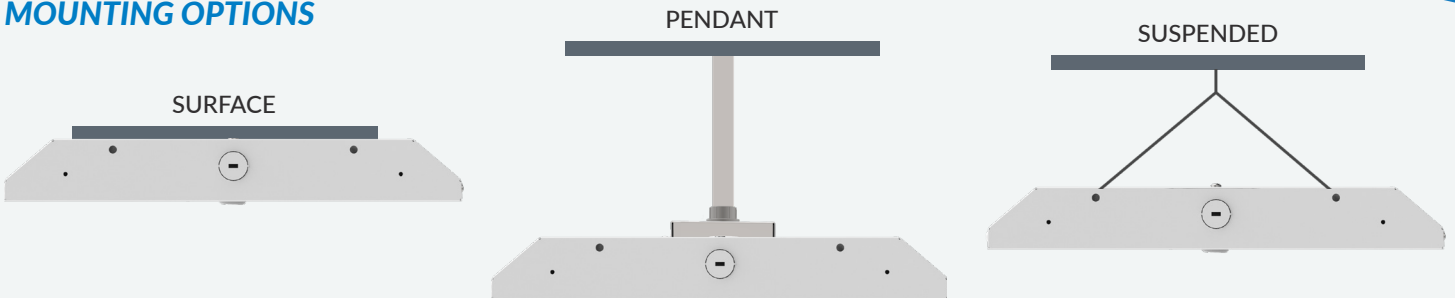

## LED SYSTEMS INFO

PART NUMBER	LUMENS	WATTS	LM/W	REPLACES
EVT-12L-U-40-FRL	12816 lm	90W	141 lm/W	175W MH, 2T5HO
EVT-18L-U-40-FRL	18285 lm	130W	138 lm/W	250W MH, 4T5HO
EVT-24L-U-40-FRL	25205 lm	180W	139 lm/W	400W MH, 6T5HO
EVT-30L-U-40-FRL	28849 lm	220W	131 lm/W	575W MH, 10T8
EVT-36L-U-40-FRL	37281 lm	270W	137 lm/W	750W MH, 8T5HO
EVT-42L-U-40-FRL	42305 lm	300W	137 lm/W	1000W MH, 10T5HO
EVT-56L-U-40-FRL	56114 lm	400W	138 lm/W	1000W MH, 10T5HO

# EVEREST

LINEAR HIGH BAY  
EVT

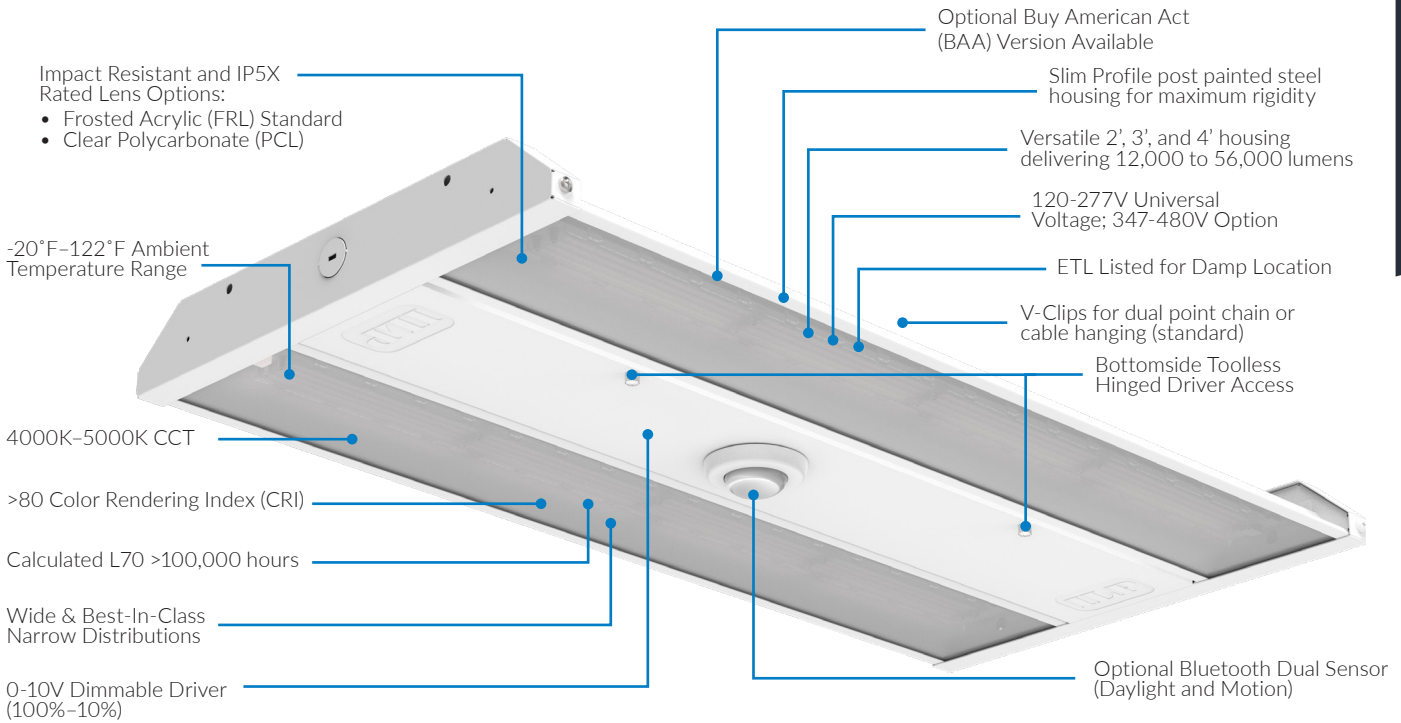

## ORDERING GUIDE

\*Options & Accessories are not shown. Please see the cut sheet on our website at [ilp-inc.com](http://ilp-inc.com) or scan the QR code below.

SERIES	LUMENS	VOLTAGE	CCT	LENS	DISTRIBUTION	BAA OPTION	
EVT 2 ft. Everest	12L 12,000 lm	U 120-277V	40 4000K	FRL Frosted Acrylic Lens (Standard)	(BLANK) Wide	(BLANK) Not BAA Compliant	
	18L 18,000 lm		50 5000K	PCL Polycarbonate Clear Lens	ND Narrow	BAA BAA Compliant	
	24L 24,000 lm						
	30L 30,000 lm						
EVT 3 ft. Everest	36L 36,000 lm						
	42L 42,000 lm						
EVT 4 ft. Everest	56L 56,000 lm						

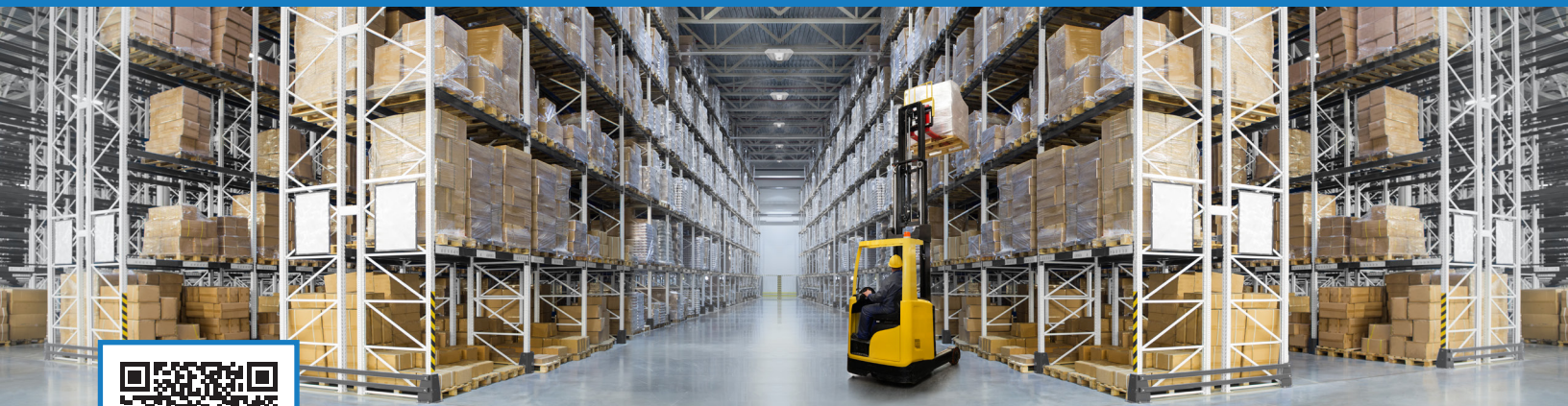

For more helpful information

## SCAN ME

Gain access to our flyer, brochure, IES files, and more by scanning the product's QR code.

# GRID FRAME HIGH BAY

## FEATURES

- 2x2 and 2x4 recessed grid high bay
- Specification-grade for new construction or renovation
- .040 aluminum prepainted housing
- Standard configuration
  - No lens
  - No wire cage
- Multiple lens options
  - Frosted acrylic
  - Clear polycarbonate
  - Frosted polycarbonate
- 11 ga. wire cage option
- Flange kit option
- Ambient temperature range -40°F up to 125°F
- 0-10V dimmable driver (100% - 5%)
- 120-277V universal voltage
- 3000K - 5000K CCT
- ETL listed for damp location
- DesignLights Consortium® premium qualified luminaire



Without Frosted Lens



Frosted Lens



## SUITABLE APPLICATIONS

- Gymsnasiums
- Car Dealerships
- Multipurpose Rooms
- Racquetball Courts  
(Must use PCL or PFL Option)

## LED SYSTEMS INFO

PART NUMBER	LUMENS	WATTS	LM/W	REPLACES
GH22-90WLED-UNIV-XX-FRL	12,166 lm	89W	137 lm/W	250W MH
GH22-115WLED-UNIV-XX-FRL	14,778 lm	113W	131 lm/W	400W MH
GH22-135WLED-UNIV-XX-FRL	17,568 lm	136W	130 lm/W	400W MH
GH24-90WLED-UNIV-XX-FRL	11,993 lm	89W	136 lm/W	3T5HO
GH24-130WLED-UNIV-XX-FRL	18,294 lm	132W	139 lm/W	400W MH
GH24-180WLED-UNIV-XX-FRL	23,081 lm	176W	131 lm/W	6T5HO

## ORDERING GUIDE

\*Options & Accessories are not shown. Please see the cut sheet on our website at [ilp-inc.com](http://ilp-inc.com) or scan the QR code below.

SERIES	WATTS	DRIVER	CCT	LENS
GH22 2' x 2' Grid Frame High Bay	90WLED	UNIV 120-277V	50 5000K	FRL Frosted Acrylic Lens
	115WLED		40 4000K	PCL Clear Polycarbonate Lens
	135WLED		35 3500K	PFL Frosted Polycarbonate Lens
GH24 2' x 4' Grid Frame High Bay	90WLED		30 3000K	(BLANK) No Lens
	130WLED			
	180WLED			



For more helpful information

# SCAN ME

Gain access to our installation instructions, IES files, and more by scanning the product's QR code.

# PREMIUM HIGH BAY TENNIS COURT

LINEAR HIGH BAY  
PHB-TC

## FEATURES

- Premium efficiency delivers maximum savings
- Aluminum body with steel channel for added rigidity
- Inverted mounting for indirect distribution
- Toolless hinged bottom ballast access door
- High gloss polyester white paint
- Riveted construction and vented ballast channel
- Polycarbonate lens (standard)
- Multiple dimming and sensor options to fully control occupied and unoccupied light levels
- 0-10V dimming driver (100% - 5%)
- 120-277V universal voltage and 347-480V high voltage via step down transformer



## SUITABLE APPLICATIONS

- Warehouses
- Manufacturing Plants
- Tennis Courts
- Gymnasiums
- Distribution Centers



## LED SYSTEMS INFO

PART NUMBER	LUMENS	WATTS	LM/W	REPLACES
PHB-495WLED-UNIV-50-TC	65,582 lm	494W	133 lm/W	1000W MH
PHB-660WLED-UNIV-50-TC	91,317 lm	667W	137 lm/W	1000W MH

## MOUNTING OPTIONS

**V-Clips (standard)** For dual point chain or cable hanging

**SMBKIT** Surface Mount V-Clip Brackets with 2" space above fixture

**FMB** Fixture Mounting Box - Includes rigid box to attach to the fixture, provides for single point mounting to accept a pendant, hook or conduit hub (sold separately)

**HUB ¾ CONDUIT**

**HOOK** Cast iron hook for single point mount

**HB-XX-18Y-PAD** Adjustable Y-Toggle Cables Kit (60", 120", or 180")



V-Clips (standard)



SMBKIT

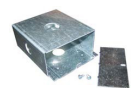

FMB



HUB ¾ CONDUIT



HOOK



HB-XX-18Y-PAD

## ORDERING GUIDE

\*Options & Accessories are not shown. Please see the cut sheet on our website at [ilp-inc.com](http://ilp-inc.com) or scan the QR code below.

SERIES	WATTS	DRIVER	CCT	MOUNTING
PHB Premium High Bay	495WLED 660WLED	UNIV 120-277 V	50 5000K 40 4000K 35 3500K 30 3000K	TC Tennis Court Inverted



For more helpful information

# SCAN ME

Gain access to our installation instructions, IES files, and more by scanning the product's QR code.

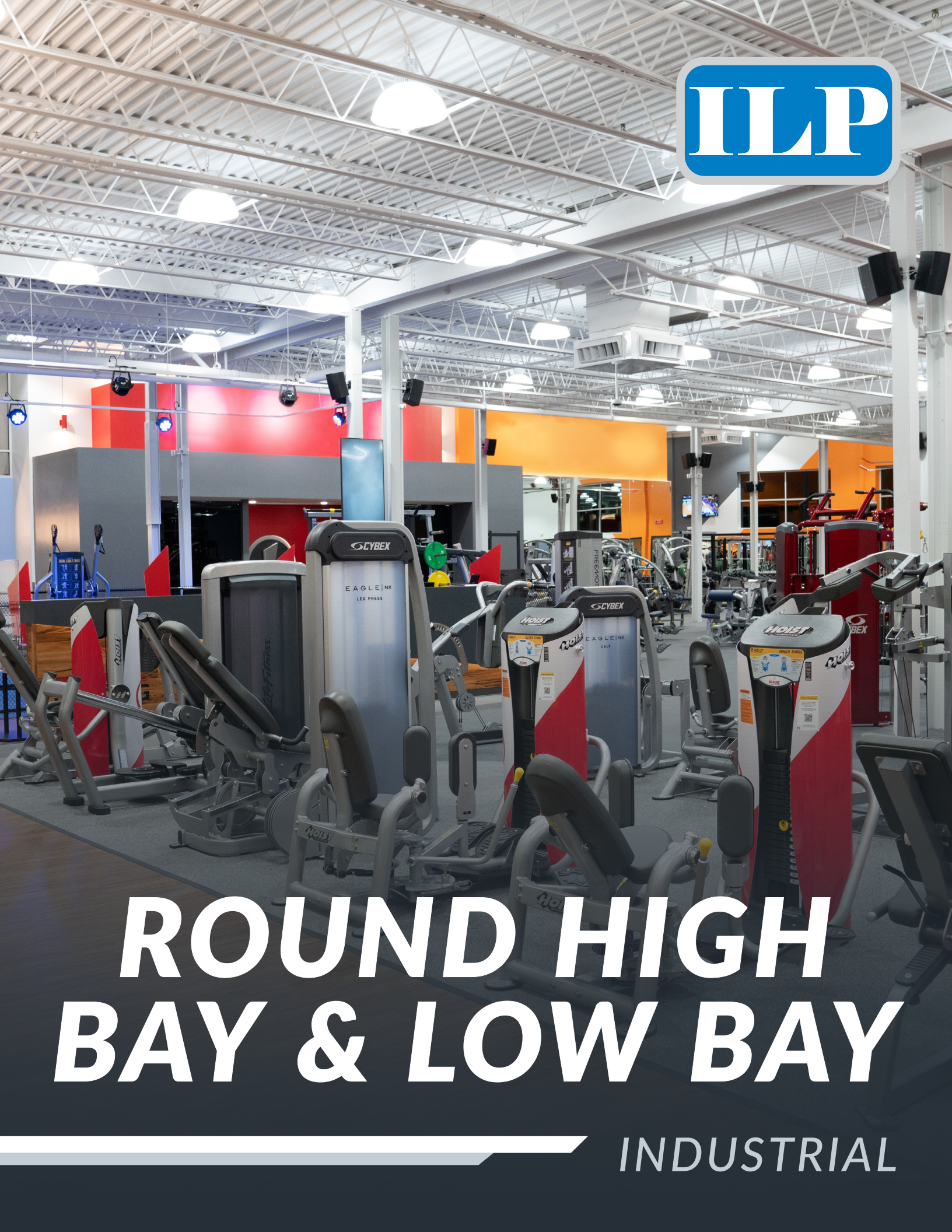

# ROUND HIGH BAY & LOW BAY

INDUSTRIAL

# SELECTION GUIDE



## ROUND HIGH BAY (RB3)

## UFO LOW BAY (UFO-LB)

SUITABLE APPLICATIONS

	ROUND HIGH BAY (RB3)	UFO LOW BAY (UFO-LB)
GYMNASIUM	✓	✓
FITNESS CENTER	✓	✓
WAREHOUSE	✓	✓
DISTRIBUTION CENTER	✓	✓
MANUFACTURING PLANT	✓	✓
RACKING		
FOOD PROCESSING	✓	
WET LOCATION	✓	✓
COOLERS / FREEZER	✓	✓
SAW MILL	✓	✓

FEATURES & PERFORMANCE

LUMEN RANGE	13,000 - 30,000	5,000 - 10,000
EFFICACY (lm/W) UP TO	136	146
CRI	>80	>80
CCT OPTIONS	40, 50	30, 40, 50
DISTRIBUTION	Wide	Wide & Narrow
VOLTAGE	120-277V - Opt. 347-480V	120-277V - Opt. 347-480V
SIZES	10" - 13"	16"
HOUSING	Round	Round
LENSING	Frosted Acrylic & Polycarbonate	Diffused Polycarbonate
LIFE (L70)	>100K	>100K
AMBIENT RANGE UP TO	-40°F - 122°F	-40°F - 145°F
EMERGENCY	✓	✓
RATINGS	WET, IP65, NSF, IK10	WET, IP65
BAA COMPLIANT		✓
DLC	Premium	Premium

BASIC CONTROLS

ON/OFF OCCUPANCY	✓	✓
ON/OFF OCCUPANCY W/ PHOTOCELL	✓	✓
ON/OFF OCCUPANCY W/ DAYLIGHT HARVESTING		✓
DAYLIGHT HARVESTING		✓
BI-LEVEL OCCUPANCY	✓	✓
BI-LEVEL OCCUPANCY W/ PHOTOCELL	✓	✓

ADVANCE GROUPING CONTROLS

SYNAPSE		✓
ENLIGHTED		✓

# RB3 ROUND HIGH BAY

## FEATURES

- IP65 rated and NSF listed round high bay
- 13,000 - 31,000 lumens
- Powder coated cold-forged aluminum housing
- Remote controlled center mounted sensor option
- IK10 impact rated primary polycarbonate lens
  - Clear (standard)
  - Frosted (optional)
- Optional diffusers
  - 16" and 22" frosted acrylic
  - 14" aluminum reflector
- Damp and wet location 347/480V and emergency options
- 120-277V universal voltage and 347-480V high voltage via step down transformer
- >80 color rendering index (CRI)
- Calculated L70 >100,000 hours
- Ambient temperature range -40°F-122°F



# RB3



Shown as 25L-31L with AD22

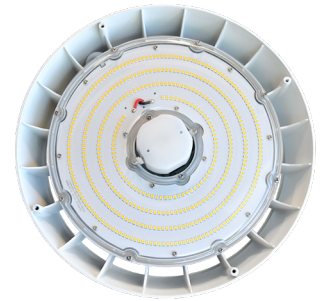

Shown with Sensor (S) option

## SENSOR

Factory installed center mounted sensor. Standard sensor operations include: on/off, bi-level dimming and photocell. Requires sensor remote control (S/RC), shown right, to program sensor.



## SUITABLE APPLICATIONS

- Food Processing
- Wet Locations
- Gymnasiums
- Distribution Centers
- Warehouses
- Manufacturing Plants

## EMERGENCY & 347/480V



**DAMP LOCATION**  
(LEDBB/D, SD347/D, SD480/D)



**WET LOCATION**  
(LEDBB/W, SD347/W, SD480/W)

Available for both Damp and Wet Locations. With a proprietary design, selecting the wet location option will allow the fixture to remain IP65 rated & NSF listed.



## LED SYSTEMS INFO

PART NUMBER	LUMENS	WATTS	LM/W	REPLACES
RB3-13L-U-50	13,376 lm	98W	136 lm/W	250W HID
RB3-19L-U-50	19,886 lm	147W	135 lm/W	400W HID
RB3-25L-U-50	26,130 lm	193W	135 lm/W	400W HID
RB3-31L-U-50	30,162 lm	224W	134 lm/W	400-600W HID



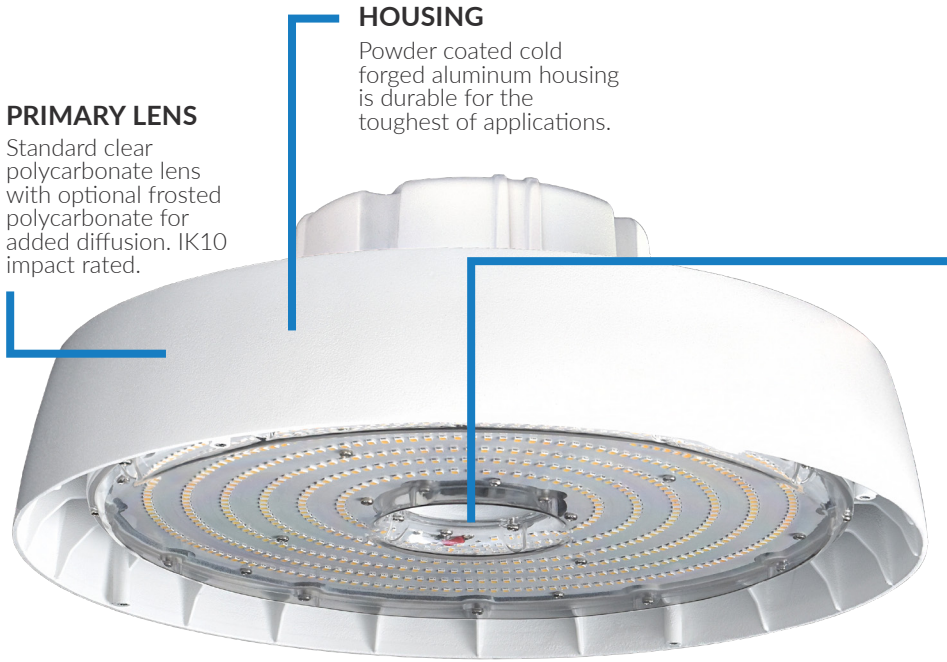

**PRIMARY LENS**

Standard clear polycarbonate lens with optional frosted polycarbonate for added diffusion. IK10 impact rated.

**HOUSING**

Powder coated cold forged aluminum housing is durable for the toughest of applications.

**CENTER MOUNTED SENSOR**

- Provides Clean Appearance
- Ensures Balanced Fixture
- Remote Control Programmed

**SENSOR OPERATIONS**

- On/Off
- Bi-Level Dimming
- Photocell

**LUMENS**

13,000 - 31,000

**EFFICACY**

Up to 136 lm/W

**ELECTRICAL**

- 0-10V Dimmable Driver
- 4kV Built-in Surge Protection

**CCT**



**DIFFUSER OPTIONS**



**REFL90**

Aluminum Reflector

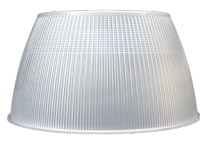

**AD16**

16" Acrylic Diffuser



**CL**

Conical Bottom Lens Options  
(Available with AD16 & AD22 options)



**AD22**

22" Acrylic Diffuser

**ORDERING GUIDE**

\*Options & Accessories are not shown. Please see the cut sheet on our website at [ilp-inc.com](http://ilp-inc.com) or scan the QR code below.

SERIES	LUMENS	DRIVER	CCT	PRIMARY LENS	DIFFUSERS
RB3	13L	U	120-277V	(BLANK) Clear Lens (included)	(BLANK) No Reflector/Diffuser (standard)
Round High Bay	19L		40	FRL Frosted Lens	AD16 16" Frosted Acrylic Diffuser
	25L				AD22 22" Frosted Acrylic Diffuser
	31L				REFL90 90° Aluminum Reflector



For more helpful information  
**SCAN ME**

Gain access to our flyer, video, promotional page and more by scanning the product's QR code.

# UFO LOW BAY

## FEATURES

- Low-profile diecast aluminum housing
- Factory select finishes: bronze (BRZ), black (BLK), silver (SLV), and white (WHT)
- Custom colors finishes available
- Frosted polycarbonate lens reduces pixelation, glare, and distraction for drivers and pedestrians
- T5 wide distribution standard; optional T5 narrow lowbay (LB) optic (concentrated distribution for atrium or exit/egress applications)
- Up to 10% uplight standard eliminates cave effect
- Mounting: quick surface mount bracket (standard), 1/2" pendant (standard), or optional trunnion mount bracket
- 120-277V universal voltage or 347-480V high voltage
- Battery backup and cold weather battery options available
- PIR occupancy, photocell and bi-level dimming sensors available
- Wireless control integrated luminaire
- 3000K, 4000K and 5000K CCT
- Calculated L70 >100,000 hours



## SUITABLE APPLICATIONS

- Warehouses
- Distribution Centers
- Manufacturing Plants
- Gymnasiums
- Coolers / Freezers
- Saw Mills

## LED SYSTEMS INFO

PART NUMBER	LUMENS	WATTS	LM/W	REPLACES
UFO-40WLED	4,985 lm	40 W	118 lm/W	150W MH
UFO-58WLED	7,135 lm	57 W	125 lm/W	175W MH
UFO-75WLED	9,266 lm	76 W	121 lm/W	250W MH
UFO-40WLED-LB	5,567 lm	40W	139 lm/W	150W MH
UFO-58WLED-LB	7,260 lm	58W	126 lm/W	175W MH
UFO-75WLED-LB	9,482 lm	77W	124 lm/W	250W MH

## ORDERING GUIDE

\*Options & Accessories are not shown. Please see the cut sheet on our website at [ilp-inc.com](http://ilp-inc.com) or scan the QR code below.

SERIES	WATTS	DRIVER	CCT	DISTRIBUTION	MOUNTING	FINISH
UFO UFO Low Bay	28WLED	UNIV 120-277V	50	(BLANK) - Wide	(BLANK) Surface Mount	(BLANK) Bronze
	40WLED	HV 347-480V	40	LB - Narrow	PEN5 60" leads for Pendant Mounting	BLK Black
	58WLED		30		SCON Side Conduit	SLV Silver
	75WLED				TRN Trunnion	WHT White



For more helpful information

# SCAN ME

Gain access to our flyer, brochure, IES files, and more by scanning the product's QR code.

# NOTES

---

---

---

---

---

---

---

---

---

---

---

---

---

---

---

---

---

---

---

---

---

---

---

---

ROUND HIGH BAY & LOW BAY  
**NOTES**



Visit us online at  
***ILP-INC.COM***

If you have any questions regarding products in this section, please go online to [ilp-inc.com](http://ilp-inc.com) or reach out to one of our sales reps for more information and pricing.



**HAZARDOUS**

INDUSTRIAL



# SELECTION GUIDE

	HAZARDOUS LOCATION VAPOR TIGHT (HZV)	HAZARDOUS LOCATION HIGH BAY (HZB)	
SUITABLE APPLICATIONS	CHEMICAL PROCESSING FACILITIES	✓	
	INDUSTRIAL & MANUFACTURING PLANTS	✓	
	ETHANOL & PETROLEUM REFINERIES	✓	
	WASTEWATER & TREATMENT FACILITIES	✓	
	POWER GENERATION FACILITIES	✓	
	COOLERS & FREEZERS	✓	
	FOOD & BEVERAGE PREPARATION	✓	
FEATURES & PERFORMANCE	LUMEN RANGE	2,000 - 24,000	12,000 - 42,000
	EFFICACY (lm/W) UP TO	156	168
	CRI	>80	>80
	CCT OPTIONS	30, 35, 40, 50	30, 35, 40, 50
	DISTRIBUTION	Wide	Wide & Narrow
	VOLTAGE	120-277V - OPT. 347-480V	120-277V - OPT. 347-480V
	SIZES	2FT, 3FT, 4FT	2FT & 4FT
	HOUSING	Linear	Linear
	LENSING	Clear & Frosted Acrylic, Clear & Frosted Polycarbonate	Clear & Frosted Acrylic, Clear & Frosted Polycarbonate
	LIFE	>100K	>100K
	AMBIENT RANGE	-40°F - 131°F	-40°F - 140°F
	EMERGENCY	✓	✓
	RATINGS	WET, IP65, IP66, IP67, NSF	WET, IP65, IP66, IP67, IP69, IK10, NSF
	CERTIFICATIONS	Class 1 Div 2 Groups A, B, C, D, Class 1 Zone 2 Iia, Iib +H2, Iic, UI844, T4 Temp Rated	Class 1 Div 2 Groups A, B, C, D, Class 1 Zone 2 Iia, Iib +H2, Iic, UI844, T4 Temp Rated
	BAA COMPLIANT	✓	✓
	DLC	Premium	Premium

# HAZARDOUS LOCATION VAPOR TIGHT

## FEATURES

- Robust hazardous location narrow body linear vapor tight
- Class 1 zone 2 groups IIA, IIB+ H2, IIC
- UL844 hazardous
- Industry-leading max ambient up to 131°F
- - Ambient range -40°F to 131°F (select models)
- Extremely high efficacy up to 156 lm/W
- 2ft, 4ft and 8ft fixture lengths
- Lumen packages ranging 2,000-24,000
- Surface, pendant, wall and suspended mounting options
- Multiple impact-resistant lens options
- Fiberglass body attributes
  - T4 housing ignition temperature rated
  - F1 weatherability rating, 5VA flame rating and 1500 PSI High Pressure Hosedown
  - IP65, IP66 and IP67, NEMA4X, NSF
  - 3000K-5000K CCT
- Calculated L70 >100,000 hours



## SUITABLE APPLICATIONS

- Chemical Processing Facilities
- Industrial & Manufacturing Facilities
- Wastewater & Water Treatment Facilities
- Food & Beverage Preparation
- Ethanol & Petroleum Refineries
- Power Generation Facilities
- Coolers & Freezers

## LED SYSTEMS INFO

\*Only HZV4 shown. Please visit the specheet on our website at [ilp-inc.com](http://ilp-inc.com) for HZV2 and HZV8

PART NUMBER	LUMENS	WATTS	LM/W	REPLACES
HZV4-3L-U-40-RAFL	3,034 lm	21W	144 lm/W	2T8
HZV4-4L-U-40-RAFL	4,074 lm	29W	142 lm/W	2T8
HZV4-5L-U-40-RAFL	5,201 lm	38W	137 lm/W	1T5HO
HZV4-6L-U-40-RAFL	6,505 lm	47W	137 lm/W	3T8
HZV4-7L-U-40-RAFL	7,549 lm	55W	137 lm/W	3T8
HZV4-8L-U-40-RAFL	8,668 lm	61W	142 lm/W	2T5HO
HZV4-9L-U-40-RAFL	9,358 lm	66W	143 lm/W	2T5HO
HZV4-10L-U-40-RAFL	10,245 lm	73W	141 lm/W	4T8
HZV4-12L-U-40-RAFL	13,010 lm	93W	146 lm/W	3T5HO

**CLASS 1 DIV 2**  
GROUPS A, B, C, D



**NEMA4X**



## ORDERING GUIDE

\*Options & Accessories are not shown. Please see the cut sheet on our website at [ilp-inc.com](http://ilp-inc.com) or scan the QR code below.

SERIES	LUMENS				DRIVER		CCT	LENS				
	2L	3L	4L	6L	U	HV		RAFL	SAFL	SACL	SPFL	SPCL
HZV2 2ft Hazardous Vapor Tight					120-277V	347V-480V	50	RAFL	Ribbed Acrylic Frosted (Standard)			
							40	SAFL	Shallow Acrylic Frosted			
							35	SACL	Shallow Acrylic Clear			
HZV4 4ft Hazardous Vapor Tight	3L	4L	5L	6L			30	SPFL	Shallow Polycarbonate Frosted			
	7L	8L	9L	10L				SPCL	Shallow Polycarbonate Clear			
	12L											
HZV8 8ft Hazardous Vapor Tight	6L	8L	10L	12L								
	14L	16L	18L	24L								

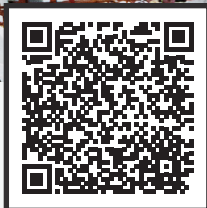

For more helpful information

**SCAN ME**

Gain access to our brochure, promotional page and more by scanning the product's QR code.

# HAZARDOUS LOCATION HIGH BAY

## FEATURES

- Robust hazardous location wide body vapor tight high bay
- Class 1 zone 2 groups IIA, IIB+ H2, IIC
- UL844 hazardous
- Industry leading max ambient up to 140°F
  - Ambient range -40°F to 140°F (select models)
- Extremely high efficacy up to 168 lm/W
- 2ft and 4ft fixture lengths
- Lumen packages ranging 12,000–40,000
- Wide and best in class narrow distribution optics
- Surface, pendant, or suspended mounting options
- IK10 impact rated lens
- Fiberglass body attributes
  - T4 housing ignition temperature rated
  - F1 weatherability rating, 5VA flame rating and 1500 PSI high pressure hosedown
  - IP65, IP66, IP67, and IP69 (2ft only), NEMA4X, NSF 3000K–5000K CCT
- Calculated L70 >100,000 hours

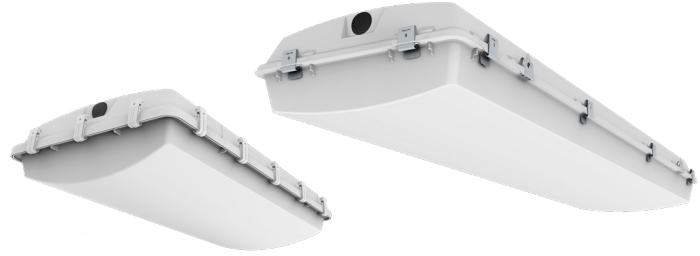

HAZARDOUS  
HZB

## SUITABLE APPLICATIONS

- Chemical Processing Facilities
- Industrial & Manufacturing Facilities
- Wastewater & Water Treatment Facilities
- Food & Beverage Preparation
- Ethanol & Petroleum Refineries
- Power Generation Facilities
- Coolers & Freezers

## LED SYSTEMS INFO

PART NUMBER	LUMENS	WATTS	LM/W	REPLACES
HZB2-12L-U-40-CAL	12,887 lm	80W	160 lm/W	250W MH, 4T8
HZB2-18L-U-40-CAL	19,188 lm	122W	157 lm/W	400W MH, 4T5HO, 6T8
HZB2-24L-U-40-CAL	24,637 lm	159W	155 lm/W	400W MH, 6T5HO
HZB4-12L-U-40-CAL	12,975 lm	79W	165 lm/W	250W MH, 4T8
HZB4-18L-U-40-CAL	20,629 lm	131W	158 lm/W	400W MH, 4T5HO, 6T8
HZB4-24L-U-40-CAL	25,617 lm	159W	162 lm/W	400W MH, 6T5HO
HZB4-30L-U-40-CAL	33,781 lm	209W	162 lm/W	575W MH, 10T8, 8T5HO
HZB4-36L-U-40-CAL	38,328 lm	241W	159 lm/W	750W MH, 10T8, 8T5HO
HZB4-40L-U-40-CAL	41,591 lm	254W	164 lm/W	1000W MH, 12T8, 10T5HO

**CLASS 1 DIV 2**  
GROUPS A, B, C, D



**NEMA4X**



## ORDERING GUIDE

\*Options & Accessories are not shown. Please see the cut sheet on our website at [ilp-inc.com](http://ilp-inc.com) or scan the QR code below.

SERIES	LUMENS		DRIVER	CCT	LENS OPTIONS		DISTRIBUTION		TEMPERATURE	
	2ft	4ft			Clear Acrylic	Frosted Acrylic	(BLANK) Wide Distribution	(BLANK) Standard Ambient Temp	(BLANK) High Ambient Temp	
HZB2 2ft Hazardous Vapor Tight High Bay	12L	24L	U	120-277V	50	CAL	Clear Acrylic	(BLANK) Wide Distribution	(BLANK) Standard Ambient Temp	
	18L	36L	HV	347-480V	40	FRAL	Frosted Acrylic	ND	Narrow Distribution	HT
						35	PCL	Clear Polycarbonate		
HZB4 4ft Hazardous Vapor Tight High Bay	12L	30L			30	PFL	Frosted Polycarbonate			
	18L	36L								
			24L	40L						



For more helpful information

**SCAN ME**

Gain access to our brochure, promotional page and more by scanning the product's QR code.



# VAPOR TIGHT

## INDUSTRIAL



# SELECTION GUIDE

### AMAZON Z SERIES (WTZ)

SUITABLE APPLICATIONS	
COOLERS & FREEZERS	✓
FOOD & BEVERAGE PREPARATION	✓
GREENHOUSE	✓
PHARMACEUTICAL	✓
HEALTHCARE	✓
EDUCATION	✓
INDUSTRIAL	✓
PARKING GARAGE	✓
HOCKEY RINKS	
SAW MILLS	✓
FEATURES & PERFORMANCE	
LUMEN RANGE	2,000 - 24,000
EFFICACY (lm/W) UP TO	156
CRI	>80
CCT OPTIONS	30, 35, 40, 50
DISTRIBUTION	Wide
VOLTAGE	120-277V - Opt. 347V, 480V
SIZES	2FT, 4FT & 8FT
HOUSING	Linear
LENSING	Clear & Frosted Acrylic, Clear & Frosted Polycarbonate
LIFE	>100K
AMBIENT RANGE	-40°F - 131°F
EMERGENCY	✓
RATINGS	WET, IP65, IP66, IP67, NSF
BAA COMPLIANT	✓
DLC	Premium
BASIC CONTROLS	
ON/OFF OCCUPANCY	✓
ON/OFF OCCUPANCY W/ PHOTOCELL	✓
BI-LEVEL OCCUPANCY	✓
BI-LEVEL OCCUPANCY W/ PHOTOCELL	✓
ADVANCE GROUPING CONTROLS	
EASYSENSE	✓
ENLIGHTED	✓





# AMAZON Z SERIES

## FEATURES

- Robust and durable narrow body linear vapor tight
- Industry leading max ambient up to 131°F
  - Ambient range -40°F to 131°F (select models)
- Extremely high efficacy up to 156 lm/W
- 2ft, 4ft and 8ft fixture lengths
- Lumen packages ranging 2,000–24,000
- Surface, pendant, wall and suspended mounting options
- Wireless grouping controls options
- Multiple lens options
- Fiberglass body attributes:
  - F1 weatherability rating and 5VA flame rating
  - IP65, IP66 and IP67, NEMA4X, NSF and 1500 PSI hosedown 3000K–5000K CCT
- Calculated L70 >100,000 hours
- 120-277V universal voltage and 347-480V high voltage via step down transformer



## SUITABLE APPLICATIONS

- Coolers & Freezers
- Food & Beverage Preparation
- Greenhouses
- Pharmaceutical
- Healthcare
- Education
- Industrial
- Parking Garages

## WTZ SERIES

The WTZ Series is an industry-leading vapor tight luminaire robustly designed for a wide variety of environments. Its sealed and gasketed NSF listed fiberglass enclosure is easy to service and clean, ideal for maintaining a safe environment for food and beverage processing. With an enhanced feature set including industry leading ambient operating temperatures, extremely high efficiency, three scalable fixture lengths, wide lumen range, various high impact lens options and multiple mounting options, the WTZ Series is the clear choice for any vapor tight applications.



## LED SYSTEMS INFO

PART NUMBER	LUMENS	WATTS	LM/W	REPLACES
WTZ2-2L-U-XX-RAFL	2,532 lm	19W	135 lm/W	1T8
WTZ2-3L-U-XX-RAFL	3,283 lm	25W	133 lm/W	1T8
WTZ2-4L-U-XX-RAFL	4,169 lm	32W	132 lm/W	2T8
WTZ2-6L-U-XX-RAFL	5,342 lm	40W	134 lm/W	3T8
WTZ4-3L-U-XX-RAFL	3,034 lm	21W	144 lm/W	1T8
WTZ4-4L-U-XX-RAFL	4,074 lm	29W	142 lm/W	2T8
WTZ4-5L-U-XX-RAFL	5,201 lm	38W	137 lm/W	1T5HO
WTZ4-6L-U-XX-RAFL	6,505 lm	47W	137 lm/W	3T8
WTZ4-7L-U-XX-RAFL	7,549 lm	55W	137 lm/W	3T8
WTZ4-8L-U-XX-RAFL	8,668 lm	61W	142 lm/W	2T5HO
WTZ4-9L-U-XX-RAFL	9,358 lm	66W	143 lm/W	2T5HO
WTZ4-10L-U-XX-RAFL	10,245 lm	73W	141 lm/W	4T8
WTZ4-12L-U-XX-RAFL	13,010 lm	93W	139 lm/W	3T5HO
WTZ8-6L-U-XX-RAFL	6,789 lm	47W	146 lm/W	2T8
WTZ8-8L-U-XX-RAFL	8,932 lm	63W	142 lm/W	2T8
WTZ8-10L-U-XX-RAFL	10,540 lm	76W	138 lm/W	3T5HO
WTZ8-12L-U-XX-RAFL	11,793 lm	81W	145 lm/W	6T8
WTZ8-14L-U-XX-RAFL	14,482 lm	103W	140 lm/W	6T8
WTZ8-16L-U-XX-RAFL	16,363 lm	117W	139 lm/W	4T5HO
WTZ8-18L-U-XX-RAFL	17,864 lm	122W	146 lm/W	6T5HO
WTZ8-24L-U-XX-RAFL	23,587 lm	162W	146 lm/W	6T5HO

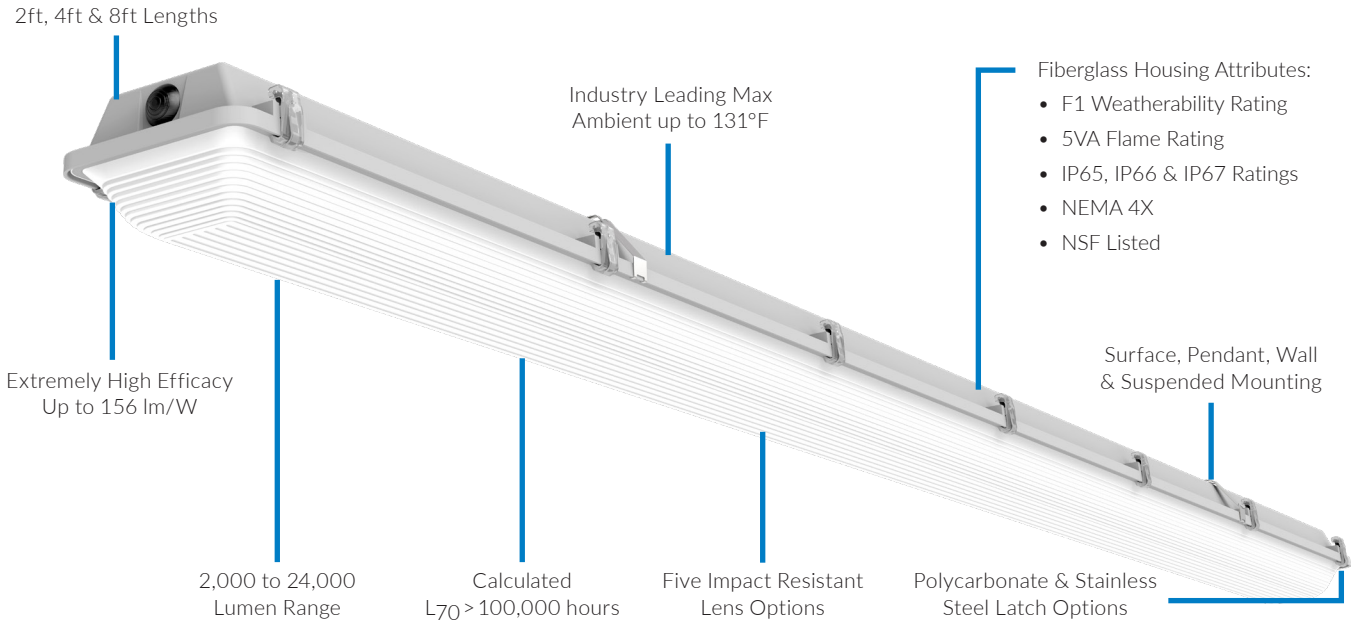

### MOUNTING OPTIONS

WTZ has you covered with multiple versatile mounting methods for any application. WTZ's project focused mounting designs provide a comprehensive offering to fulfill the most demanding applications.

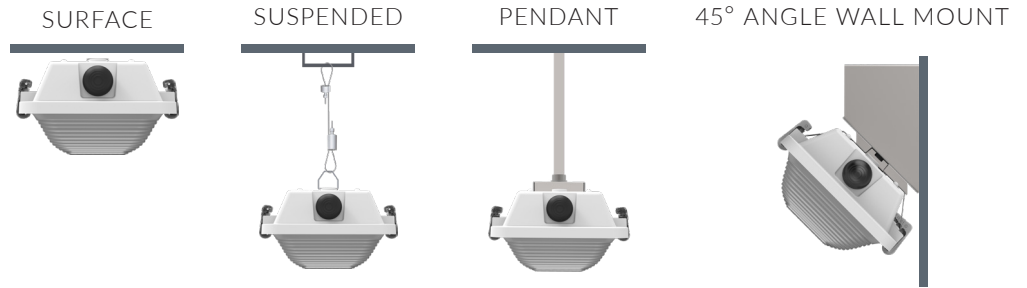

### ORDERING GUIDE

\*Options & Accessories are not shown. Please see the cut sheet on our website at [ilp-inc.com](http://ilp-inc.com) or scan the QR code below.

SERIES	AMBIENT TEMP	LUMENS				DRIVER	CCT	LENS	
		2L	3L	4L	6L			SAFL	SPFL
WTZ2	2ft Amazon	2L	3L	4L	6L	U 120-277V	50	SAFL	Ribbed Acrylic Frosted (Standard)
							40	SAFL	Shallow Acrylic Frosted
WTZ4	4ft Amazon	3L	4L	5L	6L	U 120-277V	35	SACL	Shallow Acrylic Clear
		7L	8L	9L	10L		30	SPFL	Shallow Polycarbonate Frosted
		12L						SPCL	Shallow Polycarbonate Clear
WTZ8	8ft Amazon	6L	8L	10L	12L	U 120-277V			
		14L	16L	18L	24L				

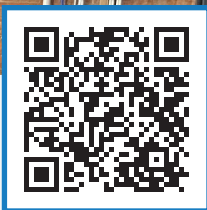
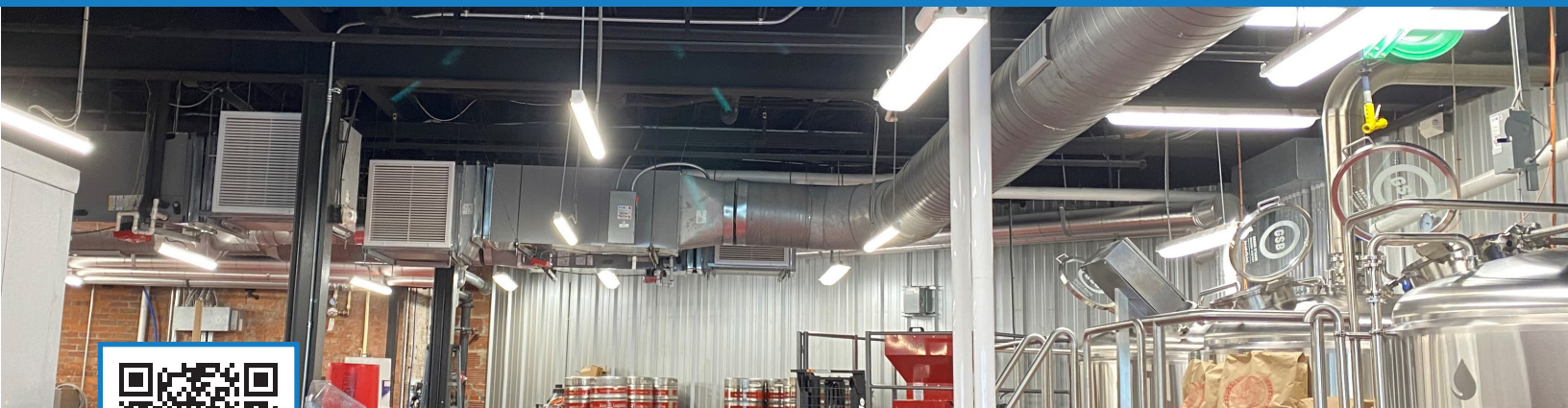

For more helpful information  
**SCAN ME**

Gain access to our brochure, promotional page and more by scanning the product's QR code.

# AMAZON X SERIES

## FEATURES

- Available in 4ft and 8ft lengths:
  - Slim version - 4.4" wide (WTXS)
  - Wide version - 7.1" wide (WTX)
- Continuous poured, closed cell polyurethane gasket
- Fiberglass body attributes:
  - IP65, IP66, IP67 (dust tight, low/high pressure water jets and immerse 1M)
  - NEMA4X, NSF listed and 5VA flame rated
- Smooth impact resistant, acrylic clear (SACL standard), acrylic frosted (SAFL), polycarbonate clear (SPCL), polycarbonate frosted (SPFL) lens options
- Polycarbonate latches (standard), stainless steel (SS) optional
- Tamper proof screws (TPS) optional
- Patent pending integrated light engine design
- 120-277 universal voltage (non-dimmable)
- 4000K and 5000K color temperatures

# X SERIES



## SUITABLE APPLICATIONS

- Parking Garages
- Pool Areas (SS Latches)
- Car Washes (SS Latches)
- Food Processing & Preparation (SS Latches)

## LED SYSTEMS INFO

PART NUMBER	LUMENS	WATTS	LM/W	REPLACES
WTXS-12W-U-50-SACL	1694 lm	12W	137 lm/W	1T8
WTX-12W-U-50-SACL	1706 lm	12W	138 lm/W	T8
WTX-24W-U-50-SACL	3295 lm	25W	134 lm/W	2T8
WTX-36W-U-50-SACL	4830 lm	37W	131 lm/W	3T8
WTX8-24W-U-50-SACL	3413 lm	25W	138 lm/W	2T8
WTX8-48W-U-50-SACL	6592 lm	49W	134 lm/W	3T8
WTX8-72W-U-50-SACL	9647 lm	74W	131 lm/W	2T5HO



## ORDERING GUIDE

\*Options & Accessories are not shown. Please see the cut sheet on our website at [ilp-inc.com](http://ilp-inc.com) or scan the QR code below.

SERIES	WATTS	DRIVER	COLOR	LENS
WTXS Amazon Slim 4ft	12W	U 120-277V Driver	50 40	SACL Smooth Acrylic Clear Lens (standard) SAFL Smooth Acrylic Frosted Lens SPCL Smooth Polycarbonate Clear Lens SPFL Smooth Polycarbonate Frosted Lens
WTX Amazon 4ft	12W 24W 36W			
WTX8 Amazon 8ft	24W 48W 72W			

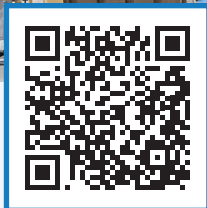

For more helpful information

# SCAN ME

Gain access to our flyer, IES files, and more by scanning the product's QR code.

# VALUE VAPOR TIGHT

## FEATURES

- Enclosed and gasketed narrow body vapor tight
- 2ft and 4ft fixture lengths
- Lumen packages ranging 3,000 to 6,000 lumens
  - Field selectable
  - lumen range 4,000 to 6,000
  - On 4ft model
- Surface, suspended, wall and 45° mounting options
- Stainless steel latches standard
- Stainless steel mounting brackets standard
- Integral wireless controls option
- 4000K and 5000K CCT options
- Ambient range of -4°F to 104°F
- Calculated L70 > 100,000 hours
- 120-277V and 0-10V dimmable driver (100%-10%)

# VVT



VAPOR TIGHT  
VVT

## SUITABLE APPLICATIONS

- Coolers & Freezers
- Food & Beverage Preparation
- Greenhouses
- Pharmaceutical
- Healthcare
- Education
- Industrial
- Parking Garages

## LED SYSTEMS INFO

PART NUMBER	LUMENS	WATTS	LM/W	REPLACES
VVT2-3L-U-XX-FRL	3,160 lm	3,160 lm	132 lm/W	1T8
VVT4-4L-U-XX-FRL	4,524 lm	4,524 lm	143 lm/W	2T8
VVT4-5L-U-XX-FRL	5,495 lm	5,495 lm	143 lm/W	1T5HO
VVT4-6L-U-XX-FRL	6,441 lm	6,441 lm	130 lm/W	3T8



## ORDERING GUIDE

\*Options & Accessories are not shown. Please see the cut sheet on our website at [ilp-inc.com](http://ilp-inc.com) or scan the QR code below.

SERIES	LUMENS	DRIVER	CCT	LENS
VVT2 2 ft Vapor Tight	3L	U 120-277V	50	FRL Frosted Lens
VVT4 4 ft Vapor Tight	4L/5L/6L		40	

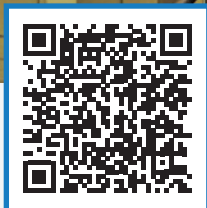

For more helpful information  
**SCAN ME**

Gain access to our brochure, IES files, and more by scanning the product's QR code.

# BLIZZARD VAPOR TIGHT HIGHBAY

## FEATURES

- Robust and durable wide body vapor tight high bay
- Industry leading max ambient up to 140°F
  - Ambient range -40°F to 140°F (select models)
- Extremely high efficacy up to 168 lm/W
- 2ft and 4ft fixture lengths
- Lumen packages ranging 12,000–40,000
- Wide and best-in-class narrow distribution optics
- Surface, pendant, or suspended mounting options
- Wireless grouping controls options
- IK10 impact rated lens
- Fiberglass body attributes
  - F1 weatherability rating, 1500 psi high pressure hosedown and 5VA flame rating
  - IP65, IP66, IP67 and IP69 (2ft only), NEMA4X, NSF
- 3000K–5000K CCT
- Calculated L70 >100,000 hours

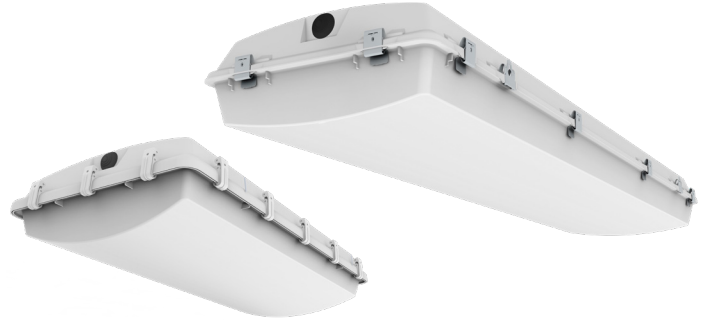

## SUITABLE APPLICATIONS

- Coolers & Freezers
- Food & Beverage Preparation
- Industrial
- Hockey Rinks
- Saw Mills
- Education
- Healthcare

## LED SYSTEMS INFO

PART NUMBER	LUMENS	WATTS	LM/W	REPLACES
BL2-12L-U-XX-CAL	12,887 lm	80W	160 lm/W	250W MH, 4T8
BL2-18L-U-XX-CAL	19,188 lm	122W	157 lm/W	400W MH, 4T5HO, 6T8
BL2-24L-U-XX-CAL	24,637 lm	159W	155 lm/W	400W MH, 6T5HO
BL4-12L-U-XX-CAL	12,975 lm	79W	165 lm/W	250W MH, 4T8
BL4-18L-U-XX-CAL	20,629 lm	131W	158 lm/W	400W MH, 4T5HO, 6T8
BL4-24L-U-XX-CAL	25,617 lm	159W	162 lm/W	400W MH, 6T5HO
BL4-30L-U-XX-CAL	33,781 lm	209W	162 lm/W	575W MH, 10T8, 8T5HO
BL4-36L-U-XX-CAL	38,328 lm	241W	159 lm/W	750W MH, 10T8, 8T5HO
BL4-40L-U-XX-CAL	38,929 lm	254W	164 lm/W	1000W MH, 12T8, 10T5HO



## ORDERING GUIDE

\*Options & Accessories are not shown. Please see the cut sheet on our website at [ilp-inc.com](http://ilp-inc.com) or scan the QR code below.

SERIES	LUMENS	DRIVER	CCT	LENS OPTIONS	DISTRIBUTION	TEMPERATURE						
							DRIVER	CCT	LENS OPTIONS	DISTRIBUTION	TEMPERATURE	
BL2	2ft Blizzard	12L	24L	U	120-277V	50	CAL	Clear Acrylic	BLANK	Wide Distribution	BLANK	Standard Ambient Temp
							FRAL	Frosted Acrylic				
							35	PCL				
BL4	4ft Blizzard	12L	30L	30	PFL <sup>2</sup>	30	PFL <sup>2</sup>	Frosted Polycarbonate	ND	Narrow Distribution	HT	High Ambient Temp
							18L	36L				
							24L	40L				

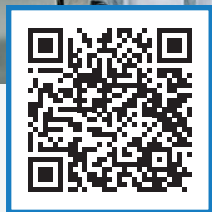

For more helpful information

# SCAN ME

Gain access to our flyer, brochure, IES files, and more by scanning the product's QR code.

# RB3 ROUND HIGH BAY

# RB3

VAPOR TIGHT  
RB3

## FEATURES

- IP65 rated and nsf listed round high bay
- 13,000 - 31,000 lumens
- Powder coated cold-forged aluminum housing
- Remote controlled center mounted sensor option
- IK10 impact rated primary polycarbonate lens
  - Clear (standard) - Frosted (optional)
- Optional diffusers
  - 16" and 22" frosted acrylic
  - 14" aluminum reflector
- 6ft cord (standard)
- 12" safety cable provided (standard)
- Mounting options
  - Cable
  - Hook (standard)
  - Pendant (½" threaded hub standard)
  - Surface mount
- Damp and wet location 347/480V and emergency options
- 120-277V universal voltage
- 0-10V dimmable driver (100% - 10%)
- 4000K and 5000K CCT
- Calculated L70 >100,000 hours
- Ambient temperature range -40°F-122°F



## SUITABLE APPLICATIONS

- Food Processing
- Wet Locations
- Gymnasiums
- Distribution Centers
- Warehouses
- Manufacturing Plants

## LED SYSTEMS INFO

PART NUMBER	LUMENS	WATTS	LM/W	REPLACES
RB3-13L-U-50	13,376 lm	98W	136 lm/W	250W HID
RB3-19L-U-50	19,886 lm	147W	135 lm/W	400W HID
RB3-25L-U-50	26,130 lm	193W	135 lm/W	400W HID
RB3-31L-U-50	30,162 lm	224W	134 lm/W	400-600W HID



## ORDERING GUIDE

\*Options & Accessories are not shown. Please see the cut sheet on our website at [ilp-inc.com](http://ilp-inc.com) or scan the QR code below.

SERIES	LUMENS	DRIVER	CCT	PRIMARY LENS	DIFFUSERS
RB3	13L	U 120-277V	50	(BLANK) Clear Lens (included)	(BLANK) No Reflector/Diffuser (standard)
Round High Bay	19L		40	FRL Frosted Lens	AD16 16" Frosted Acrylic Diffuser
	25L				AD22 22" Frosted Acrylic Diffuser
	31L				REFL90 90° Aluminum Reflector



For more helpful information

# SCAN ME

Gain access to our flyer, video, promotional page and more by scanning the product's QR code.



# VAPOR TIGHT KITS

INDUSTRIAL



# SELECTION GUIDE

	VAPOR TIGHT RETROFIT (VTR)	VAPOR TIGHT HIGH BAY RETROFIT (BLR)		
SUITABLE APPLICATIONS	COOLERS & FREEZERS	✓		
	FOOD & BEVERAGE PREPARATION	✓		
	GREENHOUSE	✓		
	PHARMACEUTICAL	✓		
	HEALTHCARE	✓		
	EDUCATION	✓		
	INDUSTRIAL	✓		
	HOCKEY RINKS	✓		
	SAW MILLS	✓		
FEATURES & PERFORMANCE	LUMEN RANGE	2,000 - 13,000	12,000 - 30,000	
	EFFICACY (lm/W) UP TO	155	154	
	CRI	>80	>80	
	CCT OPTIONS	30, 35, 40, 50	30, 35, 40, 50	
	DISTRIBUTION	Wide	Wide & Narrow	
	VOLTAGE	120-277V - Opt. 347V, 480V	120-277V - Opt. 347V, 480V	
	SIZES	4FT & 8FT	4FT	
	HOUSING	Linear	Linear	
	LENSING (OPTIONAL)	Clear & Frosted Acrylic, Clear & Frosted Polycarbonate	Clear & Frosted Acrylic, Clear & Frosted Polycarbonate	
	LIFE (L <sub>70</sub> )	>100K	>100K	
	AMBIENT RANGE	-40°F - 115°F (96W to 110°F)	-40°F - 130°F (160W to 125°F)	
	EMERGENCY	✓	✓	
	BAA COMPLIANT	✓	✓	
	DLC	Premium	Premium	
	BASIC CONTROLS	ON/OFF OCCUPANCY	✓	✓
		ON/OFF OCCUPANCY W/ PHOTOCELL	✓	✓
BI-LEVEL OCCUPANCY		✓	✓	
BI-LEVEL OCCUPANCY W/ PHOTOCELL		✓	✓	

# VAPOR TIGHT RETROFIT KIT

## FEATURES

- Easy upgrade to LED with gear tray retrofit
- Installs in less than 5 minutes
- Ability to retrofit most any vapor tight housing
- Contact factory for custom configurations
- Reduce power consumption up to 50%
- 4ft and 8ft length durable aluminum kits
- Mounting clips provided
- Universal voltage 120-277V
- 3000K, 3500K, 4000K and 5000K

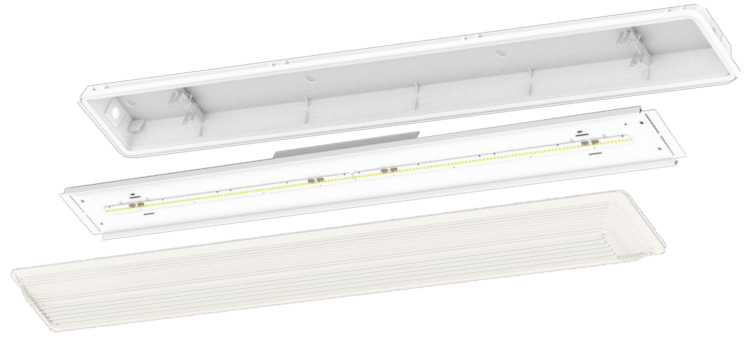

## SUITABLE APPLICATIONS

- Coolers & Freezers
- Food & Beverage Preparation
- Greenhouses
- Pharmaceutical
- Healthcare
- Education
- Industrial
- Parking Garages



## LED SYSTEMS INFO

PART NUMBER	LUMENS	WATTS	LM/W	REPLACES
VTR-18WLED-UNIV-50	2755 lm	18W	153 lm/W	1T8
VTR-25WLED-UNIV-50	3986 lm	27W	149 lm/W	2T8
VTR-28WLED-UNIV-50	4502 lm	30W	150 lm/W	2T8
VTR-40WLED-UNIV-50	5643 lm	40W	141 lm/W	1T5HO
VTR-48WLED-UNIV-50	6676 lm	49W	138 lm/W	3T8
VTR8-36WLED-UNIV-50	5582 lm	36W	155 lm/W	1T5HO
VTR8-50WLED-UNIV-50	7865 lm	52W	151 lm/W	3T8
VTR8-56WLED-UNIV-50	9122 lm	60W	152 lm/W	2T5HO
VTR8-80WLED-UNIV-50	11433 lm	80W	142 lm/W	4T8
VTR8-96WLED-UNIV-50	13735 lm	95W	144 lm/W	3T5HO

## ORDERING GUIDE

\*Options & Accessories are not shown. Please see the cut sheet on our website at [ilp-inc.com](http://ilp-inc.com) or scan the QR code below.

SERIES	WATTS	DRIVER	COLOR
VTR Vapor Tight Retrofit 4ft	18WLED	UNIV 120-277V Driver	50
	25WLED		40
	28WLED		35
VTR8 Vapor Tight Retrofit 8ft	36WLED		30
	50WLED		80WLED
	56WLED		96WLED



For more helpful information

# SCAN ME

Gain access to our cut sheets, IES files, and more by scanning the product's QR code.

# VAPOR TIGHT HIGH BAY RETROFIT

VAPOR TIGHT KITS  
BLR

## FEATURES

- Robust and durable wide body vapor tight high bay
- Industry leading max ambient up to 140°F
  - Ambient range -40°F to 140°F (select models)
- Extremely high efficacy up to 168 lm/W
- 2ft and 4ft fixture lengths
- Lumen packages ranging 12,000–40,000
- Wide and best in class narrow distribution optics
- Surface, pendant, or suspended mounting options
- Wireless grouping controls options
- IK10 impact rated lens
- Fiberglass body attributes
  - F1 weatherability rating, 1500 PSI high pressure hosedown and 5VA flame rating
  - IP65, IP66, IP67 and IP69 (2ft only), NEMA4X, NSF
- 3000K–5000K CCT
- Calculated L70 >100,000 hours

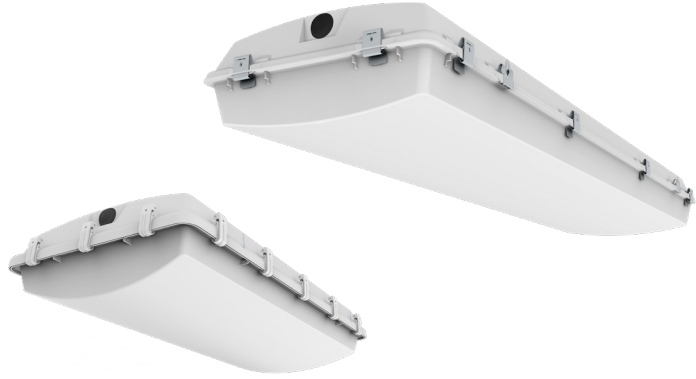

## SUITABLE APPLICATIONS

- Coolers & Freezers
- Food & Beverage Preparation
- Industrial
- Hockey Rinks
- Saw Mills
- Education
- Healthcare



## LED SYSTEMS INFO

PART NUMBER	LUMENS	WATTS	LM/W	REPLACES
BL2-12L-U-50-FRAL	12,790 lm	80W	159 lm/W	250W MH, 4T8
BL4-12L-U-50-FRAL	12,850 lm	79W	163 lm/W	250W MH, 4T8
BL4-18L-U-50-FRAL	20,430 lm	131W	156 lm/W	400W MH, 4T5HO, 6T8
BL4-24L-U-50-FRAL	25,370 lm	159W	160 lm/W	400W MH, 6T5HO

## ORDERING GUIDE

\*Options & Accessories are not shown. Please see the cut sheet on our website at [ilp-inc.com](http://ilp-inc.com) or scan the QR code below.

SERIES	LUMENS	DRIVER	CCT	LENS OPTIONS	DISTRIBUTION	TEMPERATURE
BL2 2ft Blizzard	12L 24L 18L	U 120-277V	50	CAL Clear Acrylic	(BLANK) Wide Distribution	(BLANK) Standard Ambient Temp
			40	FRAL Frosted Acrylic	ND Narrow Distribution	HT High Ambient Temp
			35	PCL Clear Polycarbonate		
BL4 4ft Blizzard	12L 30L 18L 36L 24L 40L		30	PFL Frosted Polycarbonate		



For more helpful information

# SCAN ME

Gain access to our flyer, brochure, IES files, and more by scanning the product's QR code.



COMM

# ERCCIAL



# TROFFERS

## COMMERCIAL

### SELECTION GUIDE

#### VOLUMETRIC TROFFER (VOLA)

##### SUITABLE APPLICATIONS

EDUCATION	✓
HEALTHCARE	✓
COMMERCIAL OFFICE	✓
RETAIL	✓
VANDAL RESISTANT	
CLEANROOM	
COMMERCIAL KITCHEN	
FOOD PREP	

##### FEATURES & PERFORMANCE

LUMEN RANGE	2,400 - 10,000
EFFICACY (lm/W) UP TO	151
CRI	80, 90
CCT OPTIONS	30, 35, 40, 50
VOLTAGE	120-277V - Opt. 347V
SIZES	1X4, 2x2, 2x4
DIFFUSER STYLE	Volumetric
AIR RETURN	✓
MOUNTING	Grid, Flange, Surface
RATINGS	Damp, ETL, IC
WARRANTY	5 Year (Opt. 10 Year)
DLC LISTING	Premium
NSF LISTED OPTION	
BAA COMPLIANT	✓
RETROFIT KIT OPTION	✓

##### ADVANCE GROUPING CONTROLS

EASYSense	✓
ENLIGHTED	✓
LUTRON	✓



**FLAT LENS TROFFER  
(FLT)**

**VOLUMETRIC ADJUSTABLE  
TROFFER (VAT)**

**FLAT PANEL  
(PAN)**

**BACK-LIT FLAT  
PANEL (VPAN)**

✓	✓	✓	✓
✓	✓	✓	✓
✓	✓	✓	✓
✓	✓	✓	✓
✓		✓	✓
		✓	✓
		✓	✓
		✓	✓
		✓	✓
2,300 – 4,800	2,500 – 7,500 (Lumen Selectable)	2,300 – 7,500	2,600 – 7,000 (Lumen Selectable)
125	148	132	127
80	80	80	80
30, 35, 40	30,35, 40 (CCT Selectable)	35, 40	35, 40
120-277V – Opt. 347V	120-277V – Opt. 347V	120-277V – Opt. 347V	120-277V – Opt. 347V
1X4, 2x2, 2x4	1X4, 2x2, 2x4	1X4, 2x2, 2x4	1X4, 2x2, 2x4
Flat	Volumetric	Flat	Flat
Grid, Flange, Surface	Grid, Flange, Surface	Grid, Flange, Surface, Skylight	Grid, Flange, Surface, Skylight, Suspended
Damp, ETL, IC	Damp, ETL, IC	Damp, UL, IC	Damp, UL, IC
5 Year (Opt. 10 Year)	5 Year (Opt. 10 Year)	7 Year (Opt. 10 Year)	5 Year
Standard	Premium	Premium	Standard
		✓	✓
✓	✓		
✓	✓	✓	✓
✓	✓	✓	✓
✓	✓	✓	✓

# VOLUMETRIC TROFFER

## FEATURES

- Architecturally designed volumetric troffer
- Lightweight aluminum matte white finish body
- High transmission extruded PMMA frosted acrylic lens
- Recessed, surface or flange mount
- Air return options
- Advanced wireless controls options
- 1x4, 2x2, 2x4 sizes
- 2,400 – 10,000 delivered lumens
- High efficacy – up to 151 lm/W
- 3000K – 5000K CCT
- Calculated L70 > 100,000 hours
- 0-10V dimmable driver
- DesignLights Consortium® qualified luminaire

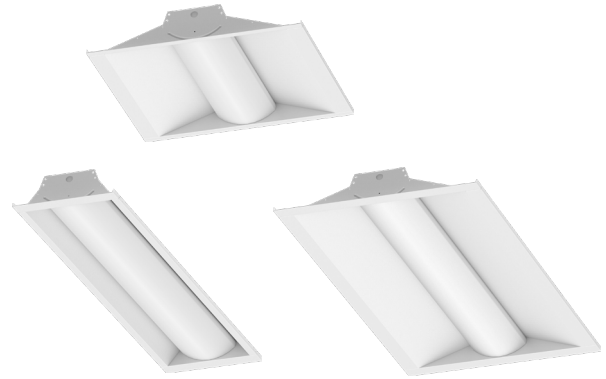

## SUITABLE APPLICATIONS

- Education
- Healthcare
- Offices
- Hallways
- Multipurpose Rooms
- Conference Rooms

## LED SYSTEMS INFO

\*Not all models shown below. Please see the cut sheet on our website at [ilp-inc.com](http://ilp-inc.com) or scan the QR code below.

PART NUMBER	LUMENS	WATTS	LM/W	REPLACES
VOLA14-30L-U-40	3,008 lm	21 W	141 lm/W	2T8
VOLA22-31L-U-40	3,069 lm	21 W	146 lm/W	2T8
VOLA24-43L-U-40	4,323 lm	29 W	148 lm/W	3T8



## ORDERING GUIDE

\*Options & Accessories are not shown. Please see the cut sheet on our website at [ilp-inc.com](http://ilp-inc.com) or scan the QR code below.

SERIES	LUMENS		DRIVER	80CRI / CCT	FINISH	AIR RETURN
VOLA14 VolumetricTroffer 1'x4'	24L	46L	U 120-277V	50	(BLANK) Pre-paint white	(BLANK) None – standard housing
	30L	52L	HV 347V	40	PAF Post-paint white	AR/W Air Return – White Reveal
	41L	62L		35		AR/B Air Return – Black Reveal
				30		
VOLA22 VolumetricTroffer 2'x2'	24L	45L		90CRI / CCT		
	31L	50L			940	
	34L	61L			935	
	39L	76L			930	
VOLA24 VolumetricTroffer 2'x4'	29L	53L				
	34L	62L				
	37L	79L				
	43L	86L				
	49L	104L				



For more helpful information

# SCAN ME

Gain access to our cut sheet, IES files and more by scanning the product's QR code.



# FLAT LENS TROFFER

## FEATURES

- Architecturally designed flat lensed volumetric troffer
- Lightweight aluminum matte white finish body
- Impact and scratch resistant PMMA frosted acrylic lens
- Tamper and vandal resistant design
- Recessed, surface or flange mount
- Advanced wireless controls options
- 1x4, 2x2, 2x4 sizes
- 2,300 – 4,800 delivered lumens
- 3000K – 4000K CCT
- Calculated L70 >100,000 hours
- 0–10V dimmable driver (100%–1%)
- 120–277V universal voltage
- DesignLights Consortium® qualified luminaire

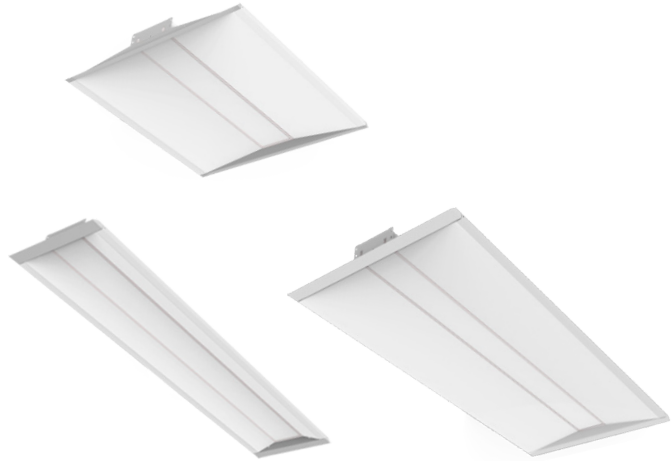

## SUITABLE APPLICATIONS

- Education
- Healthcare
- Offices
- Hallways
- Multipurpose Rooms
- Conference Rooms

## LED SYSTEMS INFO

\*Not all models shown below. Please see the cut sheet on our website at [ilp-inc.com](http://ilp-inc.com) or scan the QR code below.

PART NUMBER	LUMENS	WATTS	LM/W	REPLACES
FLT14-30WLED-U-40	3,609 lm	30W	120 lm/W	2T8
FLT22-30WLED-U-40	3,557 lm	30W	119 lm/W	2T8
FLT24-45WLED-U-40	4,832 lm	45W	108 lm/W	3T8



## ORDERING GUIDE

\*Options & Accessories are not shown. Please see the cut sheet on our website at [ilp-inc.com](http://ilp-inc.com) or scan the QR code below.

SERIES	WATTS	DRIVER	CCT
FLT14 1x4 Flat Lens Troffer	19WLED	U 120-277V	40
	30WLED		35
	45WLED		30
FLT22 2x2 Flat Lens Troffer	19WLED		
	30WLED		
	45WLED		
FLT24 2x4 Flat Lens Troffer	26WLED		
	35WLED		
	45WLED		



For more helpful information

**SCAN ME**

Gain access to our cut sheet, IES files, and more by scanning the product's QR code.

# VOLUMETRIC ADJUSTABLE TROFFER

## FEATURES

- Highly versatile volumetric center basket troffer
- Matte white post paint finish for uniform indirect illumination
- High transmission PMMA frosted polycarbonate lens
- 1x4, 2x2 and 2x4 sizes
- Recessed, surface and flange mount options
- Field Selectable or factory set lumen output
  - 2,500 to 7,500 lumen range
- Field selectable or factory set CCT
  - 3000K, 3500K and 4000K CCT
- Enlarged driver box for easy installation
- Advanced wireless controls options
  - Fixture maintains CCT selectable function
- High efficacy—up to 148 lm/W
- Calculated L70 > 100,000 hours
- 120-277V universal dimming driver (100%–10%)
- DesignLights Consortium® premium qualified luminaire

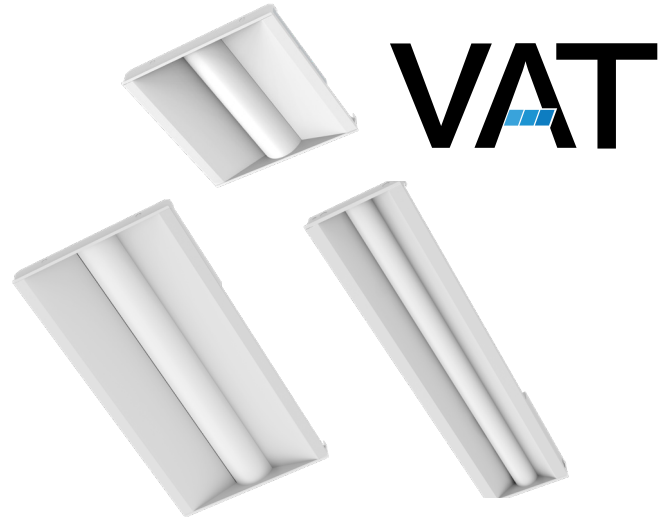

## SUITABLE APPLICATIONS

- Education
- Healthcare
- Commercial Offices
- Storage Facilities
- Retail
- Grocery Stores

## LED SYSTEMS INFO

PART NUMBER	LUMENS (Max.)	WATTS (Max.)	LM/W	REPLACES
VAT14-25L/32L/38L-U-CCTS	3,942 lm	29W	136 lm/W	2T8
VAT22-25L/31L/36L-U-CCTS	3,876 lm	29W	135 lm/W	3T8
VAT24-43L/48L/54L-U-CCTS	6,014 lm	43W	137 lm/W	3T8
VAT24-60L/64L/70L-U-CCTS	7,555 lm	56W	136 lm/W	2T5



## ORDERING GUIDE

\*Options & Accessories are not shown. Please see the cut sheet on our website at [ilp-inc.com](http://ilp-inc.com) or scan the QR code below.

	SERIES	LUMENS	DRIVER	CCT
VAT14	1x4 Volumetric Troffer	25L/32L/38L	U 120-277V	40 35 30
VAT22	2x2 Volumetric Troffer	25L/31L/36L		
VAT24	2x4 Volumetric Troffer	43L/48L/54L 60L/64L/70L		



For more helpful information

# SCAN ME

Gain access to our brochure, IES files, and more by scanning the product's QR code.

# FLAT PANEL

## FEATURES

- Slim low-profile edge-lit design with seamless frame
- Aluminum post painted housing
- PMMA LGP material – non-yellowing lens
- Impact and scratch resistant lens
- NSF option for food prep applications – non-splash zone
- 1x4, 2x2 and 2x4 sizes
- Recessed, surface and skylight mounting options
- L90=50,000 hours – L80 > 100,000 hours  
- 3x life of most competition
- Advanced controls options
- 3500K and 4000K CCT
- 0-10V dimmable driver (100% - 10%)
- Bi-level and line voltage dimming options
- 120-277V universal voltage
- IC rated for insulated ceilings
- DesignLights Consortium® premium qualified luminaire

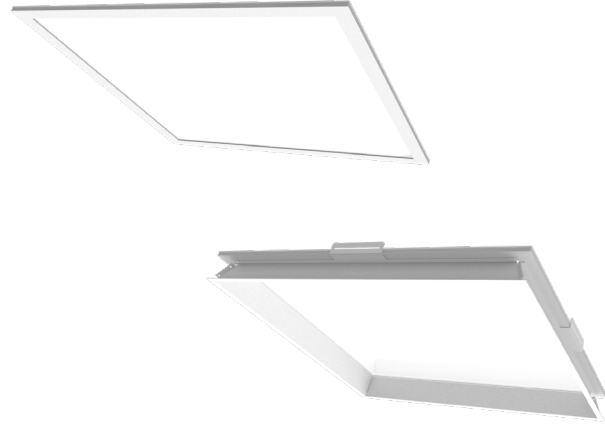

Shown with Skylight Mount Frame Option

## SUITABLE APPLICATIONS

- Education • Healthcare • Offices • Hallways • Multipurpose Rooms • Conference Rooms • Commercial Kitchens • Food Prep

## LED SYSTEMS INFO

PART NUMBER	LUMENS	WATTS	LM/W	REPLACES
PAN14-20WLED	2,419 lm	19W	128 lm/W	2T8
PAN14-30WLED	3,894 lm	31W	126 lm/W	2T8
PAN22-20WLED	2,619 lm	21W	128 lm/W	2T8
PAN22-30WLED	3,941 lm	31W	127 lm/W	3T8
PAN24-30WLED	3,999 lm	32W	127 lm/W	2T8
PAN24-36WLED	4,553 lm	36W	127 lm/W	3T8
PAN24-50WLED	6,051 lm	50W	126 lm/W	4T8
PAN24-60WLED	7,491 lm	60W	132 lm/W	5T8



## ORDERING GUIDE

\*Options & Accessories are not shown. Please see the cut sheet on our website at [ilp-inc.com](http://ilp-inc.com) or scan the QR code below.

SERIES	WATTS	DRIVER	CCT
PAN14 1x4 Edge-Lit Flat Panel	20WLED	U 120-277V	40
	30WLED		35
PAN22 2x2 Edge-Lit Flat Panel	20WLED		
	30WLED		
PAN24 2x4 Edge-Lit Flat Panel	30WLED		
	36WLED		
	50WLED		
	60WLED		



For more helpful information

# SCAN ME

Gain access to our brochure, IES files, and more by scanning the product's QR code.

# BACK-LIT FLAT PANEL

## FEATURES

- Low glare smooth uniform illumination back-lit panel
- Robust die-formed housing with white post-paint finish
- High transmission PMMA frosted len
- NSF Option for Food Prep Applications—Non-Splash Zone
- Grid, flange, surface and suspended mounting options
- 1x4, 2x2 and 2x4 sizes
- Field selectable or factory set lumen outputs  
- 2,700 to 7,000 delivered lumen range
- 3500K and 4000K CCTs
- Enlarged driver box for easy installation
- Calculated L70 >100,000 hours
- 0-10V dimmable driver (100%-10%)
- 120-277V universal voltage
- Type IC rated for insulation contact
- DesignLights Consortium® qualified luminaire

# VPAN

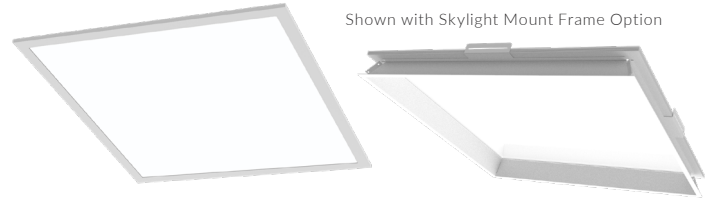

Shown with Skylight Mount Frame Option



## SUITABLE APPLICATIONS

- Education
- Healthcare
- Commercial Offices
- Retail
- Grocery Stores
- Residential
- Food Prep
- Commercial Kitchens

## LED SYSTEMS INFO

PART NUMBER	LUMENS	WATTS	LM/W	REPLACES
VPAN14-22L-U-XX	2,782 lm	22W	126 lm/W	1T8
VPAN14-27L-U-XX	3,098 lm	25W	125 lm/W	2T8
VPAN14-33L-U-XX	3,471 lm	28W	125 lm/W	2T8
VPAN22-27L-U-XX	3,133 lm	25W	127 lm/W	2T8
VPAN22-33L-U-XX	3,724 lm	30W	126 lm/W	2T8
VPAN22-44L-U-XX	4,791 lm	39W	123 lm/W	3T8
VPAN24-33L-U-XX	3,562 lm	28W	127 lm/W	2T8
VPAN24-44L-U-XX	4,638 lm	37W	124 lm/W	3T8
VPAN24-55L-U-XX	5,749 lm	48W	121 lm/W	4T8
VPAN24-66L-U-XX	6,945 lm	60W	117 lm/W	5T8

## ORDERING GUIDE

\*Options & Accessories are not shown. Please see the cut sheet on our website at [ilp-inc.com](http://ilp-inc.com) or scan the QR code below.

SERIES	LUMENS	DRIVER	CCT
VPAN14 1x4 Back-Lit Flat Panel	22L/27L/33L - Lumen Selectable	U 120-277V	40
	22L		35
	27L		
	33L		
VPAN22 2x2 Back-Lit Flat Panel	27L/33L/44L - Lumen Selectable		
	27L		
	33L		
	44L		
VPAN24 2x4 Back-Lit Flat Panel	33L/44L/55L - Lumen Selectable		
	33L		
	44L		
	55L		
	66L		



For more helpful information

# SCAN ME

Gain access to our brochure, IES files, and more by scanning the product's QR code.





# TROFFER KITS

## COMMERCIAL

### SELECTION GUIDE



#### VOLUMETRIC TROFFER RETROFIT KIT (LANCE)

##### SUITABLE APPLICATIONS

EDUCATION	✓
HEALTHCARE	✓
COMMERCIAL OFFICE	✓
RETAIL	✓
VANDAL RESISTANT	
CLEANROOM	
COMMERCIAL KITCHEN	
FOOD PREP	

##### FEATURES & PERFORMANCE

LUMEN RANGE	2,300 - 6,200
EFFICACY (lm/W) UP TO	155
CRI	80, 90
CCT OPTIONS	30, 35, 40, 50
VOLTAGE	120-277V - Opt. 347V
SIZES	1X4, 2x2, 2x4
DIFFUSER STYLE	Volumetric
AIR RETURN OPTION	✓
RETROFIT EXISTING	Recessed - Prismatic, Parabolic, Air Handling
UPGRADES EXISTING	Appearance & Light Engine
MOUNTING	Grid
INSTALLATION TIME	3 Minutes
INSTALLATION COMPONENTS	3
RATINGS	Damp, ETL for UI1598c
WARRANTY	5 Year (Opt. 10 Year)
DLC LISTING	Premium
BAA COMPLIANT	✓
NEW FIXTURE OPTION	✓

##### ADVANCE GROUPING CONTROLS

EASYSense	✓
ENLIGHTED	✓
LUTRON	✓



VALUE LANCE TROFFER RETROFIT KIT (VLN)	FLAT LENS TROFFER RETROFIT (FLTR)	RTR LED TROFFER RETROFIT KIT (RTR)
✓	✓	✓
✓	✓	✓
✓	✓	✓
✓	✓	✓
	✓	✓
		✓
		✓
		✓
		✓
		✓
		✓
3,300 - 6,800	2,200 - 5,000	2,000 - 4,800
137	126	167
80	80	80
35, 40	35, 40	35, 40
120-277V - Opt. 347V	120-277V - Opt. 347V	120-277V - Opt. 347V
2x2, 2x4	1X4, 2x2, 2x4	2x2, 2x4
Volumetric	Flat	
Recessed - Prismatic, Parabolic	Recessed - Prismatic, Parabolic	Recessed & Surface Mounted - Prismatic, Parabolic, Air Handling
Appearance & Light Engine	Appearance & Light Engine	Light Engine Only
Grid	Grid	Grid, Hard Lid, Surface
2 Minutes	3 Minutes	2 Minutes
3	3	1
Damp, ETL for UI1598c	Damp, ETL for UI1598c	Damp, ETL for UI1598c
5 Year (Opt. 10 Year)	5 Year (Opt. 10 Year)	5 Year
Premium	Standard	Premium
✓	✓	✓
✓	✓	
✓	✓	
✓	✓	✓

# VOLUMETRIC TROFFER RETROFIT KIT

## FEATURES

- Troffer retrofit kit for recessed lighting applications
- One-piece unit with two universal mounting brackets
- Average install time less than 3 minutes
- Lightweight aluminum matte white finish body
- High transmission extruded PMMA frosted acrylic lens
- Air return options
- Advanced wireless controls options
- 1x4, 2x2, 2x4 sizes
- 2,300 – 6,200 delivered lumens
- High efficacy – up to 155 lm/W
- 3000K – 5000K CCT
- Calculated L70 > 100,000 hours
- 0-10V dimmable driver (dims to 10%)
- DesignLights Consortium® premium qualified luminaire

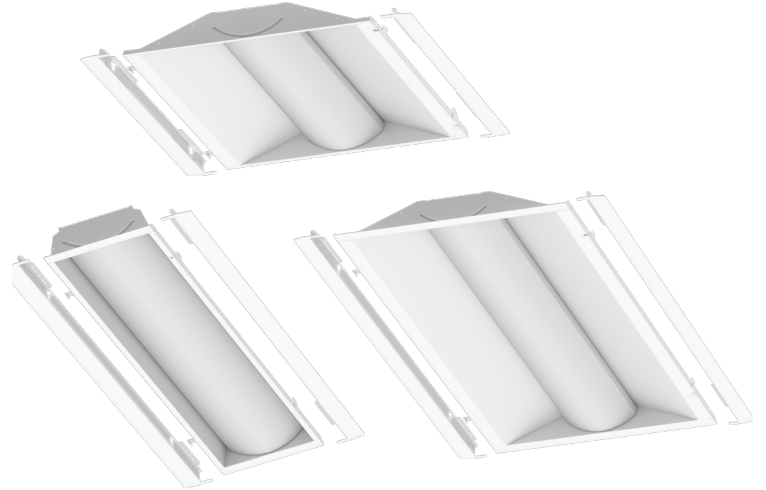

## SUITABLE APPLICATIONS

- Education
- Healthcare
- Offices
- Hallways
- Multipurpose Rooms
- Conference Rooms

## LED SYSTEMS INFO

\*Not all models shown below. Please see the cut sheet on our website at [ilp-inc.com](http://ilp-inc.com) or scan the QR code below.

PART NUMBER	LUMENS	WATTS	LM/W	REPLACES
LANCE14-29L-U-40	2,892 lm	21 W	137 lm/W	2T8
LANCE22-31L-U-40	3,120 lm	21 W	147 lm/W	2T8
LANCE24-43L-U-40	4,339 lm	29 W	149 lm/W	3T8



## ORDERING GUIDE

\*Options & Accessories are not shown. Please see the cut sheet on our website at [ilp-inc.com](http://ilp-inc.com) or scan the QR code below.

SERIES	LUMENS		DRIVER		80CRI / CCT	FINISH		AIR RETURN	
LANCE14	23L	40L	U	120-277V	50	(BLANK)	Pre-paint white	(BLANK)	Standard Mounting Brackets
LANCE Troffer Kit 1'x4'	29L	49L	HV	347V	40	PAF	Post-paint white	AR/W	Air Return White Reveal
		61L			35			AR/B	Air Return Black Reveal
					30				
LANCE22	24L	37L			90CRI / CCT				
LANCE Troffer Kit 2'x2'	31L	48L			940				
	34L				935				
					930				
LANCE24	30L	49L							
LANCE Troffer Kit 2'x4'	37L	54L							
	43L	62L							



For more helpful information

# SCAN ME

Gain access to our cut sheet and more by scanning the product's QR code.



# VALUE LANCE TROFFER RETROFIT KIT

## FEATURES

- LED retrofit kit for recessed lighting applications
- One-piece unit with two universal mounting brackets
- Universal brackets allow for installation in grid or hard lid ceilings
- Average install time less than 3 minutes
- Frosted acrylic lens
- 2x2 and 2x4 sizes available
- Advanced control option
- BAA compliant option available
- 3500K and 4000K CCT
- Calculated L70>100,000 hours
- 0-10V dimmable driver (100% - 10%)
- 120-277V universal driver
- DesignLights Consortium® premium qualified luminaire



## SUITABLE APPLICATIONS

- Education
- Healthcare
- Offices
- Hallways
- Multipurpose Rooms
- Conference Rooms

## LED SYSTEMS INFO

PART NUMBER	LUMENS	WATTS	LM/W	REPLACES
VLN22-3L-U-40	3,295 lm	3,295 lm	134 lm/W	2T8
VLN22-4L-U-40	4,511 lm	4,511 lm	129 lm/W	3T8
VLN24-3L-U-40	3,375 lm	3,375 lm	137 lm/W	2T8
VLN24-4L-U-40	4,590 lm	4,590 lm	132 lm/W	3T8
VLN24-7L-U-40	6,782 lm	6,782 lm	129 lm/W	4T8



## ORDERING GUIDE \*Options & Accessories are not shown. Please see the cut sheet on our website at [ilp-inc.com](http://ilp-inc.com) or scan the QR code below.

SERIES	LUMENS	DRIVER	CCT	BAA
VLN22 Value LANCE Troffer Kit 2' x 2'	3L	U 120-277V	40	(BLANK) Non BAA
	4L		35	BAA BAA Compliant
VLN24 Value LANCE Troffer Kit 2' x 4'	3L			
	4L			
	7L			



For more helpful information  
**SCAN ME**

Gain access to our cut sheet and more by scanning the product's QR code.

# FLAT LENS TROFFER RETROFIT

## FEATURES

- Architectural designed flat lensed troffer
- One-piece unit with two universal mounting brackets
- Average install time less than 3 minutes
- Lightweight aluminum matte white finish body
- Impact and scratch resistant pmma frosted acrylic lens
- Tamper resistant latch option
- Advanced wireless controls options
- 1x4, 2x2, 2x4 sizes
- 2,300 - 4,800 delivered lumens
- 3000K - 4000K CCT
- Calculated L70 >100,000 hours
- 0-10V dimmable driver
- 120-277V universal voltage
- DesignLights Consortium® qualified luminaire



## SUITABLE APPLICATIONS

- Education
- Healthcare
- Offices
- Hallways
- Multipurpose Rooms
- Conference Rooms

## LED SYSTEMS INFO

\*Not all models shown below. Please see the cut sheet on our website at [ilp-inc.com](http://ilp-inc.com) or scan the QR code below.

PART NUMBER	LUMENS	WATTS	LM/W	REPLACES
FLTR14-30WLED-UNIV-40	3,561 lm	30W	119 lm/W	2T8
FLTR22-30WLED-UNIV-XX	3,385 lm	30W	113 lm/W	3T8
FLTR24-45WLED-UNIV-XX	4,972 lm	45W	110 lm/W	3T8



## ORDERING GUIDE

\*Options & Accessories are not shown. Please see the cut sheet on our website at [ilp-inc.com](http://ilp-inc.com) or scan the QR code below.

SERIES	WATTS	DRIVER	CCT	DOORFRAME LATCH
FLTR14 1x4 Flat Lens Troffer Retrofit Kit	19WLED	UNIV 120-277V	40	(BLANK) Standard Latch
	30WLED		35	TRL Tamper Resistant Latch
	45WLED		30	
FLTR22 2x2 Flat Lens Troffer Retrofit Kit	19WLED			
	30WLED			
	45WLED			
FLTR24 2x4 Flat Lens Troffer Retrofit Kit	26WLED			
	35WLED			
	45WLED			



For more helpful information  
**SCAN ME**

Gain access to our cut sheet and more by scanning the product's QR code.

# RTR LED TROFFER RETROFIT KIT

## FEATURES

- One-piece construction, 2 minute install
- Designed for prismatic and parabolic troffers
- Fits between existing socket bars
- 2' x 2' and 2' x 4' available
- 2,000 – 4,800 lumen packages
- High efficacy – up to 167 lm/W
- 3500K and 4000K CCT
- 0-10V 120-277V dimmable driver
- Frosted lens option to remove shadowing and pixilation
- DesignLights Consortium® premium qualified luminaire



TROFFER KITS  
RTR

## SUITABLE APPLICATIONS

- Education
- Healthcare
- Offices
- Fitness Center



## LED SYSTEMS INFO

PART NUMBER	LUMENS	WATTS	LM/W	REPLACES
RTR22040-03	2,428 lm	16 W	150 lm/W	2T8
RTR22540-03	2,739 lm	19 W	148 lm/W	2T8
RTR24040-03	4,392 lm	32 W	136 lm/W	3T8
RTR43040-03	3,420 lm	20 W	167 lm/W	2T8
RTR44040-03	4,066 lm	26 W	160 lm/W	2T8
RTR44540-03	4,844 lm	32 W	151 lm/W	3T8

## ORDERING GUIDE

\*Options & Accessories are not shown. Please see the cut sheet on our website at [ilp-inc.com](http://ilp-inc.com) or scan the QR code below.

SERIES	LUMENS	COLOR	GEN
RTR2 2x2 Troffer Retrofit Kit	20 - 2000 Lumens	40	03
	25 - 2500 Lumens	35	
	40 - 4000 Lumens		
RTR4 2x4 Troffer Retrofit Kit	30 - 3000 Lumens		
	40 - 4000 Lumens		
	45 - 4500 Lumens		



For more helpful information  
**SCAN ME**

Gain access to our flyer, cut sheet and more by scanning the product's QR code.



# STRIPS

## COMMERCIAL

# SELECTION GUIDE

### QWIKLINK LINEAR STRIP (QL)

SUITABLE APPLICATIONS	
EDUCATION	✓
HEALTHCARE	✓
COMMERCIAL OFFICE	✓
RETAIL	✓
STORAGE FACILITY	✓
GROCERY STORE	✓
RESIDENTIAL	✓
STAIRWELL	✓
INDUSTRIAL	✓
FEATURES & PERFORMANCE	
LUMEN RANGE	1,200 - 5,200 (Lumen Selectable)
EFFICACY (lm/W) UP TO	130
CRI	>80
CCT OPTIONS	30, 35, 40 (CCT Selectable)
VOLTAGE	120-277V
DIMMING RANGE	100%-10%
AMBIENT RANGE	-4°F - 131°F
SIZES	2FT & 4FT
WIDTH	2.5"
LENS STYLE	Flat
UPLIGHT WITH LENS	10%
MOUNTING	Continuous Run, Pendant, Surface, Suspended
SENSOR MOUNTING	End
RATINGS	Damp, ETL
DLC	Premium
BAA COMPLIANT	
RETROFIT KIT OPTION	
BASIC CONTROLS	
ON/OFF OCCUPANCY	✓
DAYLIGHT HARVESTING	✓
BI-LEVEL OCCUPANCY	✓
BI-LEVEL OCCUPANCY WITH PHOTOCELL	✓
ADVANCE GROUPING CONTROLS	
EASYSENSE	
ENLIGHTED	
LUTRON	





FZ LOW PROFILE STRIP (FZ)	VS STRIP (VS)	SLIM STRIP (SS)	FZ LOW PROFILE STRIP (FX)
✓	✓	✓	✓
✓	✓	✓	✓
✓	✓	✓	✓
✓	✓	✓	✓
✓	✓	✓	✓
✓	✓	✓	✓
✓	✓	✓	✓
✓	✓	✓	✓
✓	✓	✓	✓
✓	✓	✓	✓
✓	✓	✓	✓
2,000 - 17,000	2,600 - 12,000	3,300 - 12,000	1,800 - 10,000
169	133	135	149
>80	>80	>80	>80
30, 35, 40, 50	40, 50	35, 40, 50	40, 50
120-277V - Opt. 347-480V	120-277V - Opt. 347-480V	120-277V - Opt. 347-480V	120-277V - Opt. 347-480V
100%-10% standard (1% Dim Opt)	100%-10%	100%-10%	
-4°F - 120°F	-4°F - 122°F	-4°F - 122°F	-4°F - 118°F
2FT, 4FT & 8FT	2FT, 4FT & 8FT	4FT & 8FT	4FT & 8FT
4.3"	3.36"	2.36"	2.9" & 4.3"
Flat	Round	Round	
4%	12%	9%	4%
Continuous Run, Pendant, Surface, Suspended	Continuous Run, Pendant, Surface, Suspended	Continuous Run, Pendant, Surface, Suspended	Continuous Run, Pendant, Surface, Suspended
Integral & End	End	End	End
Damp, ETL	Damp, ETL	Damp, ETL	Damp, ETL
Premium	Premium	Premium	Premium
✓			✓
✓	✓		✓
✓	✓	✓	✓
✓	✓	✓	✓
✓	✓	✓	✓
✓	✓	✓	✓
✓			
✓			
✓			

# QWIKLINK LINEAR STRIP

## FEATURES

- Versatile specification grade linear strip solution
- Steel housing with white powdercoat finish
- 2ft and 4ft lengths available
- High transmission PMMA frosted acrylic lens
- Ceiling, wall, pendant or suspension mounting options
- QWIKLINK connector allows for easy and seamless connection up to 64 linear feet
- Factory set or field selectable lumen output (1,200 lm to 5,200 lm)
- Factory set or field selectable CCT (3000K - 3500K - 4000K)
- High efficacy—up to 130 lm/W
- 10% uplight standard
- Calculated L70 >100,000 hours
- 0-10V dimmable driver (100%-10%)
- 120-277V universal voltage
- DesignLights Consortium® premium qualified luminaire



## QWIKLINK ACCESSORIES



**QWIKLINK Connector** allows for toolless and seamless connection up to 64 linear feet per electrical power entry. Two QWIKLINK connectors included with every fixture.



**QWIKLINK Sensor**, field installed, integrates with single or multiple fixtures for occupancy & photocell controls. Utilizing the included QL connector allows the sensor to be installed within seconds with no additional wiring required in the field.



**QWIKLINK Cable** available in 7.9" (QL20) & 60" (QL150) lengths allow for angled and distant fixture connections.

## SUITABLE APPLICATIONS

- Education
- Healthcare
- Residential
- Industrial
- Commercial Offices
- Storage Facilities
- Stairwells & Passageways with Sensor
- Retail
- Grocery Stores



## LED SYSTEMS INFO

PART NUMBER	LUMENS	WATTS	LM/W	REPLACES
QL2-12L-U-CCTS	1,291 lm	9 W	144 lm/W	1T8
QL2-20L-U-CCTS	2,064 lm	15 W	139 lm/W	2T8
QL2-25L-U-CCTS	2,546 lm	19 W	136 lm/W	2T8
QL4-18L-U-CCTS	1,952 lm	13 W	145 lm/W	1T8
QL4-22L-U-CCTS	2,349 lm	16 W	146 lm/W	2T8
QL4-25L-U-CCTS	3,383 lm	24 W	143 lm/W	2T8
QL4-30L-U-CCTS	3,087 lm	21 W	147 lm/W	2T8
QL4-39L-U-CCTS	4,133 lm	29 W	140 lm/W	2T8
QL4-50L-U-CCTS	5,211 lm	38 W	138 lm/W	2T5

# QWIKLINK

STRIPS  
QL

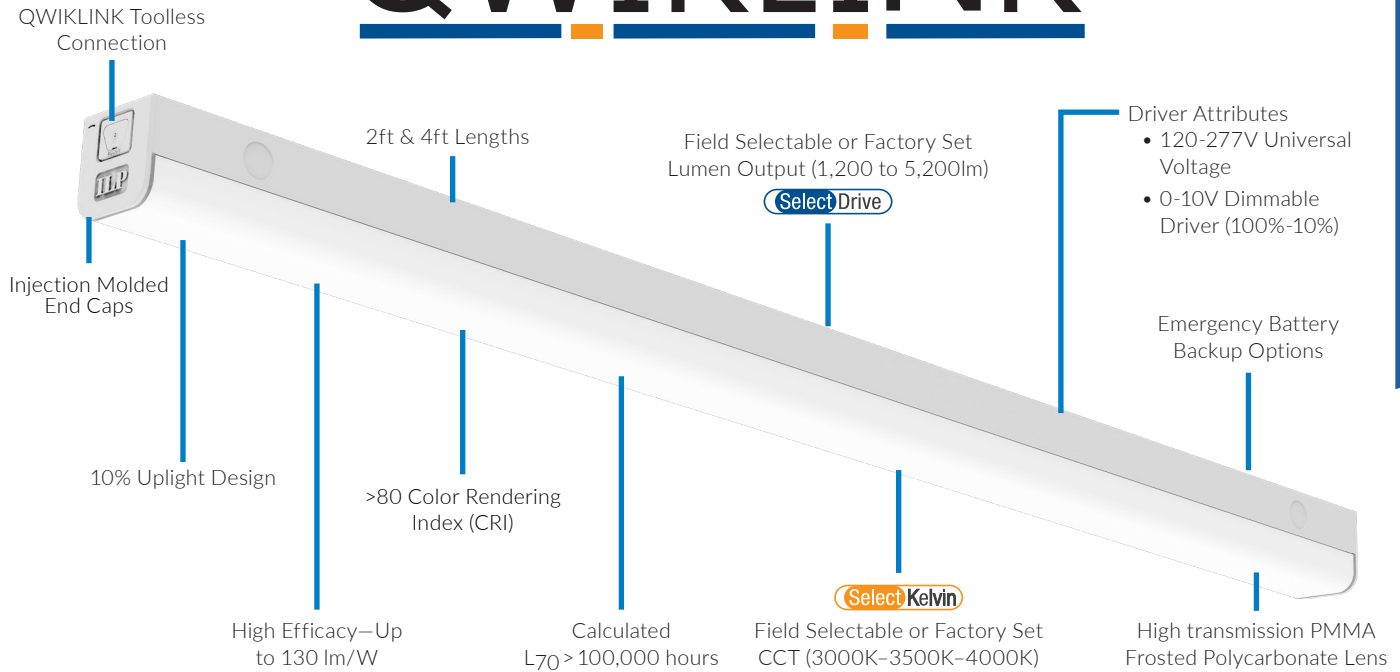

## ORDERING GUIDE

\*Options & Accessories are not shown. Please see the cut sheet on our website at [ilp-inc.com](http://ilp-inc.com) or scan the QR code below.

SERIES	LUMENS	DRIVER	CCT
QL2 2ft QWIKLINK Strip	12/20/25L - Lumen Selectable 12L 20L 25L	U 120-277V	CCTS - 30/35/40 CCT Selectable 40 35 30
QL4 4ft QWIKLINK Strip	18/22/30L - Lumen Selectable 18L 22L 30L		
QL4 4ft QWIKLINK Strip	25/39/50L - Lumen Selectable 25L 39L 50L		



For more helpful information

**SCAN ME**

Gain access to our promotional page, brochure and more by scanning the product's QR code.

# FZ LOW PROFILE STRIP

## FEATURES

- Durable steel construction
- Frosted acrylic lens available
- Multiple dimming and sensor options to fully control occupied and unoccupied light levels
- 3000K, 3500K, 4000K, and 5000K color options available
- 0-10V dimmable driver (100% - 5%)
- Dry and damp location listed
- DesignLights Consortium® qualified luminaire



## SUITABLE APPLICATIONS

- Schools • Manufacturing Plants • Retail Applications
- Warehouses or Distribution Centers



## LED SYSTEMS INFO

PART NUMBER	LUMENS	WATTS	LM/W	REPLACES
FZ2-16W-U-40-FRAL	1,981 lm	16 W	121 lm/W	2T8
FZ2-29W-U-40-FRAL	3,440 lm	29 W	118 lm/W	3T8
FZ4-20W-U-40-FRAL	3,138 lm	22W	141 lm/W	2T8
FZ4-32W-U-40-FRAL	4,386 lm	33W	135 lm/W	3T8
FZ4-40W-U-40-FRAL	5,858 lm	40W	146 lm/W	2T8
FZ4-55W-U-40-FRAL	7,399 lm	54W	137 lm/W	4T8
FZ8-40W-U-40-FRAL	6,125 lm	44W	140 lm/W	3T8
FZ8-64W-U-40-FRAL	9,016 lm	65W	138 lm/W	2T5HO
FZ8-80W-U-40-FRAL	11,944 lm	82W	147 lm/W	6T8
FZ8-110W-U-40-FRAL	14,820 lm	108W	138 lm/W	4T5HO

## ORDERING GUIDE

\*Options & Accessories are not shown. Please see the cut sheet on our website at [ilp-inc.com](http://ilp-inc.com) or scan the QR code below.

SERIES	WATTS	DRIVER	CCT	LENS OPTIONS
<b>FZ2A</b> Low-Profile Strip 2ft	<b>16W</b>	<b>U</b> 120-277 V Driver	<b>30</b>	(BLANK) No Lens
	<b>29W</b>		<b>35</b>	<b>FRAL</b> Frosted Acrylic Lens
			<b>40</b>	
			<b>50</b>	
<b>FZ4</b> Low-Profile Strip 4ft	<b>20W</b>			
	<b>32W</b>			
	<b>40W</b>			
	<b>55W</b>			
<b>FZ8</b> Low-Profile Strip 8ft	<b>40W</b>			
	<b>64W</b>			
	<b>80W</b>			
	<b>110W</b>			



For more helpful information

# SCAN ME

Gain access to our cut sheet and more by scanning the product's QR code.



# VS STRIP

## FEATURES

- Architectural design LED strip fixture
- Steel housing with white powdercoat finish
- 2ft, 4ft and 8ft lengths available
- Multiple dimming and sensor options to fully control occupied and unoccupied light levels
- Round frosted acrylic lens
- Ceiling, wall, or suspension mounting options
- Junction box cover included
- 3500K, 4000K and 5000K CCT
- Calculated L70 > 100,000 hours
- 0-10V dimmable driver (100%-10%)
- 120-277V universal voltage
- -4°F to 122°F ambient temperature range
- DesignLight Consortium® premium qualified luminaire



## SUITABLE APPLICATIONS

- Education
- Healthcare
- Commercial Offices
- Storage Facilities
- Grocery Stores
- Residential
- Industrial

## LED SYSTEMS INFO

PART NUMBER	LUMENS	WATTS	LM/W	REPLACES
VS2-2L-U-40-FRL	2,600 lm	20 W	130 lm/W	1T8
VS4-3L-U-40-FRL	3,325 lm	25 W	133 lm/W	2T8
VS4-4L-U-40-FRL	4,620 lm	35 W	132 lm/W	1T5HO
VS4-6L-U-40-FRL	5,980 lm	46 W	130 lm/W	3T8
VS8-6L-U-40-FRL	5,980 lm	46 W	130 lm/W	1T12HO
VS8-8L-U-40-FRL	8,580 lm	65 W	132 lm/W	2T5HO
VS8-12L-U-40-FRL	11,700 lm	90 W	130 lm/W	4T8

## ORDERING GUIDE

\*Options & Accessories are not shown. Please see the cut sheet on our website at [ilp-inc.com](http://ilp-inc.com) or scan the QR code below.

SERIES	WATTS	DRIVER	CCT	LENS
VS2 Value Strip 2ft	2L	U 120-277V	50 40 35	FRL Frosted Acrylic Lens
VS4 Value Strip 4ft	3L 4L 6L			
VS8 Value Strip 8ft	6L 8L 12L			



For more helpful information  
**SCAN ME**

Gain access to our cut sheet and more by scanning the product's QR code.

# SLIM STRIP

## FEATURES

- Ultra slim architectural design LED strip fixture
- Steel housing with white powdercoat finish
- 4ft and 8ft lengths available
- Multiple dimming and sensor options to fully control occupied and unoccupied light levels
- Round frosted acrylic lens
- Ceiling, wall, or suspension mounting options
- Mounting Brackets (standard) for suspended or surface mounting
- Junction box cover included
- 3500K, 4000K and 5000K CCT options available
- 0-10V dimmable driver (100%-10%)
- 120-277V universal voltage
- -4°F to 122°F ambient temperature range
- DesignLight Consortium® premium qualified luminaire



## SUITABLE APPLICATIONS

- Education
- Healthcare
- Commercial Offices
- Storage Facilities
- Grocery Stores
- Residential
- Industrial

## LED SYSTEMS INFO

PART NUMBER	LUMENS	WATTS	LM/W	REPLACES
SS4-3L-U-40-FRL	3,458 lm	26 W	133 lm/W	2T8
SS4-4L-U-40-FRL	4,655 lm	35 W	133 lm/W	1T5HO
SS4-6L-U-40-FRL	6,026 lm	46 W	131 lm/W	3T8
SS8-6L-U-40-FRL	6,118 lm	46 W	133 lm/W	1T12HO
SS8-8L-U-40-FRL	8,775 lm	65 W	135 lm/W	2T5HO
SS8-12L-U-40-FRL	11,790 lm	90 W	131 lm/W	4T8

## ORDERING GUIDE

\*Options & Accessories are not shown. Please see the cut sheet on our website at [ilp-inc.com](http://ilp-inc.com) or scan the QR code below.

SERIES	WATTS	DRIVER	CCT	LENS
SS4 Slim Strip 4ft	3L	U 120-277V	50	FRL Frosted Acrylic Lens
	4L		40	
	6L		35	
SS8 Slim Strip 8ft	6L			
	8L			
	12L			



For more helpful information

# SCAN ME

Gain access to our cut sheet and more by scanning the product's QR code.

# FX LOW PROFILE STRIP

STRIPS  
FX

## FEATURES

- Available in 4ft and 8ft Lengths:
  - Slim version - 2.9" wide (FXS)
  - Wide version - 4.4" wide (FX)
- Durable steel construction
- Patent pending integrated light engine design
- 120-277V universal voltage (non-dimmable)
- High efficacy - up to 152 lm/W
- 4000K and 5000K CCT
- 5 year warranty
- ETL damp and dry location listed
- DesignLights Consortium® qualified luminaire



## SUITABLE APPLICATIONS

- Schools
- Manufacturing Plants
- Warehouses
- Distribution Centers
- Retail Applications
- Grocery Stores

## LED SYSTEMS INFO

PART NUMBER	LUMENS	WATTS	LM/W	REPLACES
FXS4-12W-U-40	1,809 lm	12 W	146 lm/W	1T8
FX4-12W-U-40	1,821 lm	12 W	147 lm/W	1T8
FX4-24W-U-40	3,508 lm	25 W	142 lm/W	2T8
FX4-36W-U-40	5,121 lm	37 W	136 lm/W	3T8
FXS8-24W-U-40	3,634 lm	25 W	148 lm/W	1T5HO
FX8-24W-U-40	3,657 lm	25 W	149 lm/W	2T8
FX8-48W-U-40	7,110 lm	49 W	144 lm/W	2T5HO
FX8-72W-U-40	10,290 lm	74 W	139 lm/W	4T8

## ORDERING GUIDE

\*Options & Accessories are not shown. Please see the cut sheet on our website at [ilp-inc.com](http://ilp-inc.com) or scan the QR code below.

SERIES		WATTS	DRIVER	CCT
FXS4	Low-Profile Slim Strip 4ft	12W	U 120-277V	50 40
FX4	Low-Profile Strip 4ft	12W 24W 36W		
FXS8	Low-Profile Slim Strip 8ft	24W		
FX8	Low-Profile Strip 8ft	24W 48W 72W		

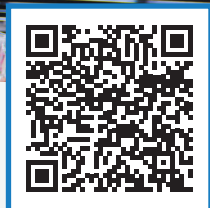

For more helpful information

**SCAN ME**

Gain access to our cut sheet and more by scanning the product's QR code.



STRIPS  
DSC

BE ON THE LOOKOUT FOR OUR NEWEST FIXTURE

# DISCOVERY



## COMING SOON

- Two lens options (flat & round)*
- Clean exterior with no visible fasteners*
- Great strip fixture option for commercial settings*
- Pendant or surface mount installations*
- Industrial reflector accessory*





# STRIP KITS

COMMERCIAL

## SELECTION GUIDE

SUITABLE APPLICATIONS	FEATURES & PERFORMANCE	BASIC CONTROLS	ADVANCE GROUPING CONTROLS
EDUCATION	LUMEN RANGE	ON/OFF OCCUPANCY	EASYSense
COMMERCIAL OFFICE	EFFICACY (lm/W) UP TO	DAYLIGHT HARVESTING	ENLIGHTED
RETAIL	CRI	BI-LEVEL OCCUPANCY	LUTRON
STORAGE FACILITY	CCT OPTIONS	BI-LEVEL OCCUPANCY WITH PHOTOCELL	
GROCERY STORE	VOLTAGE		
STAIRWELL	DIMMING RANGE		
INDUSTRIAL	AMBIENT RANGE		
	SIZES		
	WIDTH		
	LENS STYLE		
	UPLIGHT WITH LENS		
	SENSOR MOUNTING		
	RATINGS		
	DLC		
	BAA COMPLIANT		
	FIXTURE OPTION		



**LOW PROFILE STRIP RETROFIT**

**RX LOW PROFILE STRIP RETROFIT**

(RZ)	(RX)
✓	✓
✓	
✓	
✓	✓
✓	✓
✓	✓
✓	✓
✓	✓
✓	✓
3,000 - 17,000	1,800 - 7,100
169	149
>80	>80
30, 35, 40, 50	40, 50
120-277V - Opt. 347-480V	120-277V - Opt. 347-480V
100%-10% Standard (1% Dim Opt)	
-4°F - 120°F	-4°F - 117°F
4FT & 8FT	4FT & 8FT
4.3" Standard (Custom Widths Available)	4.3" - 5.5"
Flat	
4%	
Integral & End	End
Damp, ETL	Damp, ETL
Premium	Standard
✓	✓
✓	✓
✓	✓
✓	✓
✓	✓
✓	✓
✓	
✓	
✓	

# LOW PROFILE STRIP RETROFIT

## FEATURES

- Durable steel construction
- Frosted acrylic lens available
- 4ft and 8ft lengths available
- Retrofits existing 4.3" wide strips (standard)
  - custom widths available
- Multiple dimming and sensor options to fully control occupied and unoccupied light levels
- 3000K, 3500K, 4000K, and 5000K CCT
- 120V-277V universal voltage
- 0-10V dimmable driver (100% - 10%)
- L90>54,000 hours
- DesignLights Consortium® premium qualified luminaire
- Parts included in this kit: 4ft/8ft

- LED channel x 1 / x 1
- LED driver plate x 1 / x 1- x2
- LED driver plate x 1 / x 1- x2
- Fixture ID label x 1 / x 1
- Self-drilling screws x 5 / x 5- x 7
- Driver screws x 2 / x 2- x 4
- QDC driver x 1 / x 1
- QDC power x 1 / x 1



## SUITABLE APPLICATIONS

- Education
- Grocery Stores
- Manufacturing Plants
- Warehouses
- Distribution Centers
- Retail Applications



## LED SYSTEMS INFO

PART NUMBER	LUMENS	WATTS	LM/W	REPLACES
RZ4-20W-U-40-FRAL	3,138 lm	22W	141 lm/W	2T8
RZ4-32W-U-40-FRAL	4,386 lm	33W	135 lm/W	3T8
RZ4-40W-U-40-FRAL	5,858 lm	40W	146 lm/W	2T8
RZ4-55W-U-40-FRAL	7,399 lm	54W	137 lm/W	4T8
RZ8-40W-U-40-FRAL	6,125 lm	44W	140 lm/W	4T5HO
RZ8-64W-U-40-FRAL	9,016 lm	65W	138 lm/W	4T5HO
RZ8-80W-U-40-FRAL	11,944 lm	82W	147 lm/W	4T5HO
RZ8-110W-U-40-FRAL	14,820 lm	108W	138 lm/W	4T5HO

## ORDERING GUIDE

\*Options & Accessories are not shown. Please see the cut sheet on our website at [ilp-inc.com](http://ilp-inc.com) or scan the QR code below.

SERIES	WATTS	DRIVER	CCT	LENS OPTIONS
RZ4 Strip Retrofit 4ft	20W	U 120-277V	50	(BLANK) No Lens
	32W		40	FRAL Frosted Acrylic Lens
	40W		35	
	55W		30	
RZ8 Strip Retrofit 8ft	40W			
	64W			
	80W			



For more helpful information  
**SCAN ME**

Gain access to our cut sheet and more by scanning the product's QR code.



# RX

## FEATURES

- Retrofit existing strips - 4.3" to 5.5" wide
  - All-in-one adjustable cover
  - Aligns to existing fixture width
  - Retrofit in under 5 minutes
- Patent pending intergrated light engine design
- 120 - 277 universal voltage (non-dimmable)
- High efficacy - up to 152 lm/W
- 4ft and 8ft options
- 4000K and 5000K color temperatures
- ETL damp and dry location listed
- 5 year warranty
- DesignLight Consortium® qualified luminaire



## SUITABLE APPLICATIONS

- Warehouses
- Manufacturing Plants
- Distribution Centers
- Schools
- Retail Applications
- Grocery Stores



## LED SYSTEMS INFO

PART NUMBER	LUMENS	WATTS	LM/W	REPLACES
RX4-12W-U-40	1,821 lm	12 W	147 lm/W	1T8
RX8-24W-U-40	3,508 lm	25 W	142 lm/W	2T8
RX4-24W-U-40	3,657 lm	25 W	149 lm/W	2T8
RX8-48W-U-40	7,110 lm	49 W	144 lm/W	4T8

## ORDERING GUIDE

\*Options & Accessories are not shown. Please see the cut sheet on our website at [ilp-inc.com](http://ilp-inc.com) or scan the QR code below.

SERIES	WATTS	DRIVER	COLOR
RX4 Strip Retrofit 4ft	12W	U 120-277V Driver	50
	24W		40
RX8 Strip Retrofit 8ft	24W		
	48W		



For more helpful information

# SCAN ME

Gain access to our flyer, cut sheet and more by scanning the product's QR code.



# WRAPS

## COMMERCIAL

### SELECTION GUIDE



#### CURVED WRAP & CURVED WIDE BASE WRAP (SQ & SQ-WB)

SUITABLE APPLICATIONS		
EDUCATION		✓
HEALTHCARE		✓
COMMERCIAL OFFICE		✓
STORAGE FACILITY		✓
WAREHOUSE		✓
WORKSTATION/TASK		✓
HALLWAY		✓
MULTIPURPOSE		✓
FEATURES & PERFORMANCE		
LUMEN RANGE		3,000 - 10,000
EFFICACY (lm/W) UP TO		129
CRI		>80
CCT OPTIONS		30, 35, 40, 50
VOLTAGE		120-277V - Opt. 347-480V
DIMMING RANGE		100%-10% Standard (1% Dim Opt)
AMBIENT RANGE		-4°F - 130°F
SIZES		2FT, 4FT & 8FT
WIDTH		5.8" Standard (12" with -WB Option)
LENS STYLE		Curved, Frosted Acrylic
MOUNTING		Surface, Suspended, Continuous Row
SENSOR MOUNTING		Integral & End
RATINGS		Damp, ETL
DLC		Standard
BAA COMPLIANT		✓
BASIC CONTROLS		
ON/OFF OCCUPANCY		✓
DAYLIGHT HARVESTING		✓
BI-LEVEL OCCUPANCY		✓
BI-LEVEL OCCUPANCY WITH PHOTOCELL		✓
ADVANCE GROUPING CONTROLS		
EASYSENSE		✓
ENLIGHTED		✓
LUTRON		✓



**FNW LED NARROW WRAP & FWW LED WIDE WRAP (FNW & FWW)**

**SHALLOW WRAP (FWS)**

✓	✓
✓	✓
✓	✓
✓	✓
✓	✓
✓	✓
✓	✓
✓	✓
2,000 - 8,000	3,000 - 10,000
132	132
>80	>80
35, 40, 50	30, 35, 40, 50
120-277V - Opt. 347-480V	120-277V - Opt. 347-480V
100%-10% Standard (1% Dim Opt)	100%-10%
-4°F - 114°F	-4°F - 114°F
4FT & 8FT	4FT & 8FT
8.8" Standard (13.3" with FWW Models)	9.1" Standard
Curved, Frosted Acrylic	Prismatic, Frosted Acrylic
Surface, Suspended, Continuous Row	Surface & Suspended
End	Integral & End
Damp, ETL	Damp, ETL
Standard	Premium & Standard
✓	✓
✓	✓
✓	✓
✓	✓
✓	✓
	✓
✓	

# CURVED WRAP & CURVED WIDE BASE WRAP

## FEATURES

- 2ft, 4ft and 8ft configurations
- Also available in WB (wide base models)
- Sleek curved profile frosted acrylic impact resistant lens
- .040" aluminum pre-painted white housing
- Ceiling, wall or suspension mounting options
- Multiple dimming and sensor options to fully control occupied and unoccupied light levels
- Suitable for installing in continuous runs
- 3000K - 5000K CCT
- 0-10V dimmable driver (100% - 10%)
- 120-277V universal voltage
- Calculated L70>100,000 hours @ 25°C per TM-21-11
- DesignLights Consortium® qualified luminaire

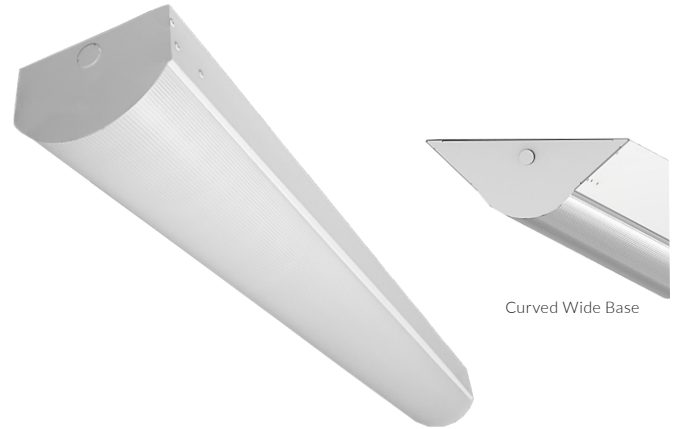

Curved Wide Base

## SUITABLE APPLICATIONS

- Offices
- Hospitals
- Education
- Hallways
- Work Station Task Lighting
- Multipurpose Rooms

## LED SYSTEMS INFO

PART NUMBER	LUMENS	WATTS	LM/W	REPLACES
SQ2-16WLED-UNIV-40	1,983 lm	17 W	117 lm/W	1T8
SQ2-22WLED-UNIV-40	2,595 lm	23 W	115 lm/W	1T8
SQ4-16WLED-UNIV-40	2,078 lm	16 W	127 lm/W	1T8
SQ4-30WLED-UNIV-40	3,694 lm	30 W	123 lm/W	2T8
SQ4-44WLED-UNIV-40	5,086 lm	44 W	116 lm/W	3T8
SQ8-32WLED-UNIV-40	4,018 lm	32 W	126 lm/W	2T8
SQ8-60WLED-UNIV-40	7,329 lm	60 W	122 lm/W	4T8
SQ8-88WLED-UNIV-40	10,236 lm	89 W	115 lm/W	6T8



## ORDERING GUIDE

\*Options & Accessories are not shown. Please see the cut sheet on our website at [ilp-inc.com](http://ilp-inc.com) or scan the QR code below.

SERIES	WATTS	DRIVER		CCT
		UNIV	120-277V	
SQ2	2ft Curved Wrap	16WLED		50
		22WLED		40
				35
SQ4	4ft Curved Wrap	16WLED		30
		30WLED		
		44WLED		
SQ8	8ft Curved Wrap	32WLED		
		60WLED		
		88WLED		



SQ

For more helpful information  
**SCAN ME**

Gain access to our cut sheet and more  
by scanning the product's QR code.



SQ-WB

# FNW LED NARROW WRAP & FWW LED WIDE WRAP

WRAPS  
FNW & FWW

## FEATURES

- Narrow and sleek design w/ 9" width
- Also available in FWW (LED wide wrap models)
- Molded endcap
- 4ft and 8ft available
- 2,200 – 8,000 lumens
- 3500K, 4000K and 5000K CCT
- 0-10V 120-277V dimmable driver
- Frosted impact resistant lens
- Sensor options
- DesignLights Consortium® qualified luminaire

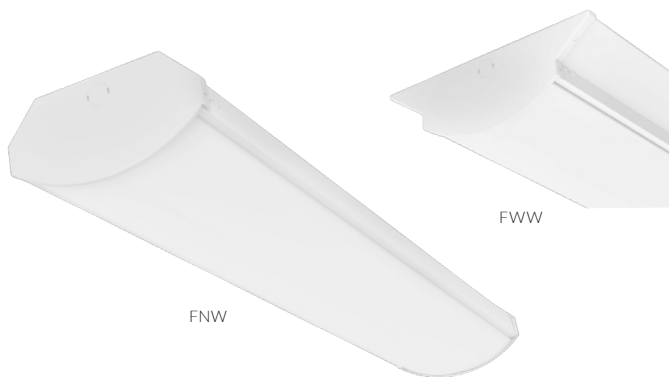

## SUITABLE APPLICATIONS

- Education
- Offices
- Work Station Task Lighting
- Hospitals
- Hallways
- Multipurpose Rooms



## LED SYSTEMS INFO

PART NUMBER	LUMENS	WATTS	LM/W	REPLACES
FNW42240-01	2,227 lm	18 W	124 lm/W	1T8
FNW42540-01	2,437 lm	20 W	122 lm/W	2T8
FNW43040-01	2,988 lm	25 W	122 lm/W	2T8
FNW44040-01	3,945 lm	35 W	113 lm/W	3T8
FNW84040-01	4,071 lm	31 W	132 lm/W	2T8
FNW85040-01	5,048 lm	39 W	129 lm/W	2T8/2T12
FNW86040-01	5,975 lm	49 W	122 lm/W	2T5HO
FNW88040-01	7,891 lm	70 W	113 lm/W	4T8/2T12HO

## ORDERING GUIDE

\*Options & Accessories are not shown. Please see the cut sheet on our website at [ilp-inc.com](http://ilp-inc.com) or scan the QR code below.

SERIES	LUMENS	CCT	GEN
FNW4 - 4ft	22 - 2200 Lumens	50	01
	25 - 2500 Lumens	40	
	30 - 3000 Lumens	35	
	40 - 4000 Lumens		
FNW8 - 8ft	40 - 4000 Lumens		
	50 - 5000 Lumens		
	60 - 6000 Lumens		
	80 - 8000 Lumens		



For more helpful information  
**SCAN ME**

Gain access to our cut sheet and more by scanning the product's QR code.

# SHALLOW WRAP

## FEATURES

- 4ft and 8ft configurations
- Low profile shallow wrap
- Specification grade for new construction
- Suitable for continuous runs
- 23 gauge die-formed steel housing
- Surface mount or suspended
- Prismatic wrap around lens
- Multiple dimming and sensor options to fully control occupied and unoccupied light levels
- Wire cage option available
  - Replaces prismatic lens
- Ample KOs on back and ends
- 0-10V dimmable driver (100%-5%)
- 3000K - 5000K CCT
- DesignLights Consortium® qualified luminaire



## SUITABLE APPLICATIONS

- Education
- Offices
- Work Station Task Lighting
- Hospitals
- Hallways
- Multipurpose Rooms

## LED SYSTEMS INFO

PART NUMBER	LUMENS	WATTS	LM/W	REPLACES
FWS-20WLED-UNIV-40	2,872 lm	22W	131 lm/W	1T8
FWS-30WLED-UNIV-40	3,773 lm	30W	125 lm/W	2T8
FWS-40WLED-UNIV-40	4,811 lm	40W	119 lm/W	1T5HO
FWS-55WLED-UNIV-40	6,175 lm	54W	115 lm/W	3T8
FWS-70WLED-UNIV-40	7,880 lm	70W	112 lm/W	4T8
FWS8-40WLED-UNIV-40	5,587 lm	43W	130 lm/W	2T8
FWS8-55WLED-UNIV-40	6,862 lm	54W	127 lm/W	4T8
FWS8-80WLED-UNIV-40	9,823 lm	80W	123 lm/W	2T5HO

## ORDERING GUIDE

\*Options & Accessories are not shown. Please see the cut sheet on our website at [ilp-inc.com](http://ilp-inc.com) or scan the QR code below.

SERIES	WATTS	DRIVER	CCT
FWS 4ft Shallow Wrap	20WLED	UNIV 120-277V	50
	30WLED		40
	40WLED		35
	55WLED		30
	70WLED		
FWS8 8ft Shallow Wrap	40WLED		
	55WLED		
	80WLED		



For more helpful information

# SCAN ME

Gain access to our cut sheet and more by scanning the product's QR code.





# ***TLED PRODUCTS***

COMMERCIAL



# FST T8 TLED

## FEATURES

- Pre-wired for single or double ended LED tubes
- 4ft and 8ft available
- 2 lamp – 4 lamp 4ft T8 option (lamps not included)
- Multiple reflector options
- White ballast cover
- 91% white aluminum
- Multiple socket options
  - Unshunted
  - Shunted
- 5 year warranty
- ETL listed for damp locations



Shown with White Reflector Option

TLED PRODUCTS  
FST TLED

enviro**brite**



## SUITABLE APPLICATIONS

- Schools
- Manufacturing Plants
- Grocery Stores
- Retail Applications
- Warehouses
- Distribution Centers

## ORDERING GUIDE

\*Options & Accessories are not shown. Please see the cut sheet on our website at [ilp-inc.com](http://ilp-inc.com) or scan the QR code below.

SERIES	TYPE	REFLECTOR	SOCKET	OPTIONS
FST41 - 4ft, 1 Lamp	T8	B - White Ballast Cover	U - Unshunted	PWS <sup>1</sup> Pre-Wired Kit Option for Single Ended LED Tubes
FST42 - 4ft, 2 Lamp		W - White Aluminum Reflector	S - Shunted	PWD <sup>2</sup> Pre-Wired Kit Option for Double Ended LED Tubes

FST82 - 8ft, 2 Lamp

FST84 - 8ft, 4 Lamp

<sup>1</sup>Compatible with Unshunted Sockets

<sup>2</sup>Compatible with Shunted Sockets



For more helpful information

**SCAN ME**

Gain access to our cut sheet and more by scanning the product's QR code.

# FNW & FWW T8 TLED WRAP FIXTURES

- Schools
- Offices
- Hallways
- Hospitals

## FEATURES

- Pre-wired for single or double ended LED tubes
- Narrow (9"-FNW) and wide (13"-FWW) widths
- Molded end caps
- 4ft and 8ft available
- 1 lamp – 6 lamp 4ft T8 options (lamps not included)
- 4ft – 1-3 lamps
- 8ft – 2-6 lamps
- Multiple socket options
  - Unshunted
  - Shunted
- Frosted impact resistant lens

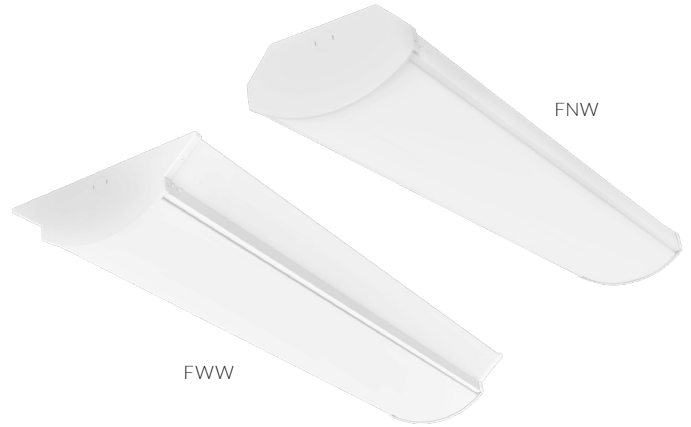

TLED PRODUCTS  
FNW & FWW TLED

envirobrite



## SUITABLE APPLICATIONS

- Schools
- Multipurpose Rooms
- Grocery Stores
- Retail Applications
- Warehouses
- Distribution Centers

## ORDERING GUIDE

\*Options & Accessories are not shown. Please see the cut sheet on our website at [ilp-inc.com](http://ilp-inc.com) or scan the QR code below.

SERIES	TYPE	SOCKET	OPTIONS
FNW43 - 4ft, 3 Lamps Narrow Housing	T8	U - Unshunted	PWS <sup>1</sup> Pre-Wired Kit Option for Single Ended LED Tubes
FNW86 - 8ft, 6 Lamps Narrow Housing		S - Shunted	PWD <sup>2</sup> Pre-Wired Kit Option for Double Ended LED Tubes
FWW43 - 4ft, 3 Lamps Wide Housing			
FWW86 - 8ft, 6 Lamps Wide Housing			

<sup>1</sup>Compatible with Unshunted Sockets

<sup>2</sup>Compatible with Shunted Sockets



For more helpful information  
**SCAN ME**

Gain access to our cut sheet and more by scanning the product's QR code.

- Work Station Task Lighting

- Multipurpose Rooms

# RSB T8 STRIP BRACKET KIT

## FEATURES

- 4ft & 8ft Available
- 1 lamp – 4 lamp 4ft T8 options (lamps not included)
- Designed for compatibility with type B Bypass Lamps Series
  - Consult factory for compatible options with type A and type C lamps
- Multiple bracket options
  - CS - adjustable width - 4.1" to 5.6"
  - 43 - fixed 4.3" width
- Multiple socket options
  - Unshunted
  - Shunted
- Tek screw slots for easy lamp centering
- Pre-wired kit options for single or double ended LED tubes

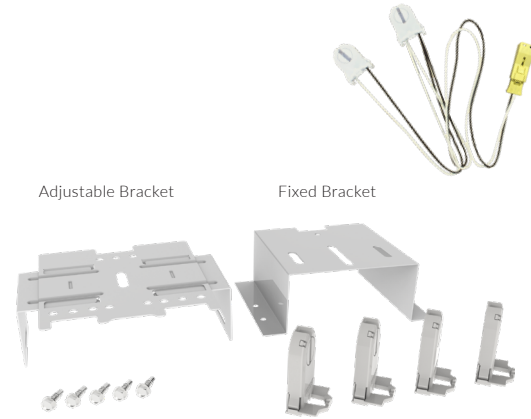

TLED PRODUCTS  
RSB

envirobrite



## SUITABLE APPLICATIONS

- Schools
- Manufacturing Plants
- Grocery Stores
- Retail Applications
- Warehouses
- Distribution Centers

## ORDERING GUIDE

\*Options & Accessories are not shown. Please see the cut sheet on our website at [ilp-inc.com](http://ilp-inc.com) or scan the QR code below.

SERIES	TYPE	BRACKET	SOCKET	OPTIONS
RSB41 - 4ft, 1 Lamp	T8	CS - Adjustable Width	U - Unshunted	<b>PWS<sup>1</sup></b> Pre-Wired Kit Option for Single Ended LED Tubes
RSB42 - 4ft, 2 Lamp		43 - 4.3 Fixed Width	S - Shunted	<b>PWD<sup>2</sup></b> Pre-Wired Kit Option for Double Ended LED Tubes
RSB82 - 8ft, 2 Lamp				
RSB84 - 8ft, 4 Lamp				

<sup>1</sup>Compatible with Unshunted Sockets

<sup>2</sup>Compatible with Shunted Sockets



For more helpful information  
**SCAN ME**

Gain access to our cut sheet and more by scanning the product's QR code.

# RST T8 TLED STRIP RETROFIT KIT

## FEATURES

- 4ft and 8ft available
- 1 lamp - 4 lamp T8 options (lamps not included)
- Designed for compatibility with Type B Bypass lamps
  - Consult factory for compatible options with type A and type C lamps
- Multiple bracket options
  - CS - adjustable width - 4.1" to 5.6"
  - 43 - Fixed 4.3" width
- Pre-wired kit options for single and double ended LED tubes
- Multiple reflector options
  - White ballast cover
  - 95% enhanced aluminum
  - 91% white aluminum
- Multiple socket options
  - Shunted
  - Unshunted



envirobrite



## SUITABLE APPLICATIONS

- Schools
- Manufacturing Plants
- Grocery Stores
- Retail Applications
- Warehouses
- Distribution Centers

## ORDERING GUIDE

\*Options & Accessories are not shown. Please see the cut sheet on our website at [ilp-inc.com](http://ilp-inc.com) or scan the QR code below.

SERIES	TYPE	REFLECTOR	BRACKET	SOCKET	OPTIONS
RST41 - 4ft, 1 Lamp	T8	B - White Ballast Cover	CS - Adjustable Width	U - Unshunted	PWS <sup>1</sup> Pre-Wired Kit Option for Single Ended LED Tubes
RST42 - 4ft, 2 Lamp		W - White Aluminum	43 - 4.3 Fixed Width	S - Shunted	PWD <sup>2</sup> Pre-Wired Kit Option for Double Ended LED Tubes
		E - Enhanced Aluminum			
RST82 - 8ft, 2 Lamp					
RST84 - 8ft, 4 Lamp					

<sup>1</sup> Compatible with Unshunted Sockets

<sup>2</sup> Compatible with Shunted Sockets



For more helpful information

**SCAN ME**

Gain access to our cut sheet and more by scanning the product's QR code.

# RTB T8 TLED TROFFER BRACKET KIT

## FEATURES

- 2ft x 2ft and 2ft x 4ft available
- 2 lamp and 3 lamp T8 options (lamps not included)
- Designed for compatibility with Type B Bypass lamps
  - Consult factory for compatible options with type A and type C lamps
- Screws to top or side of existing troffer housing
- Multiple socket options
  - Shunted
  - Unshunted
- Pre-wired kit options for single or double ended LED tubes
- Parts included in these kits:
  - 2 brackets
  - 4 sockets for 2 lamp kit
  - 6 sockets for 3 lamp kit
  - 5 tek screws

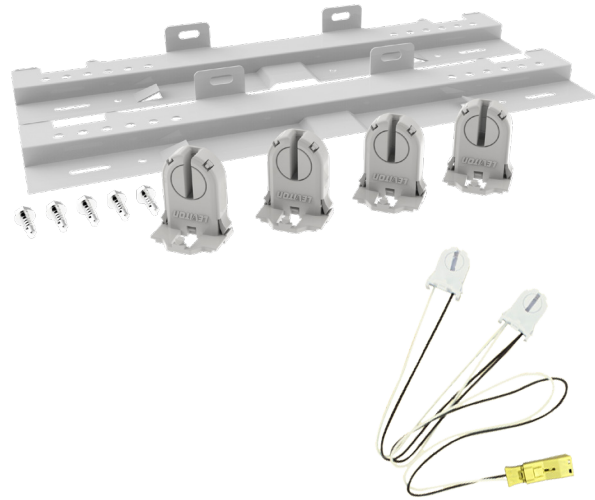

TLED PRODUCTS  
RTB

envirobrite



## SUITABLE APPLICATIONS

- Offices
- Hallways
- Conference Rooms
- Multipurpose Rooms

## ORDERING GUIDE

\*Options & Accessories are not shown. Please see the cut sheet on our website at [ilp-inc.com](http://ilp-inc.com) or scan the QR code below.

SERIES	TYPE	SOCKET	OPTIONS
RTB22 - 2x2, 2 Lamp	T8	U - Unshunted	<b>PWS<sup>1</sup></b> Pre-Wired Kit Option for Single Ended LED Tubes
RTB23 - 2x2, 3 Lamp		S - Shunted	<b>PWD<sup>2</sup></b> Pre-Wired Kit Option for Double Ended LED Tubes
RTB42 - 2x4, 2 Lamp			
RTB43 - 2x4, 3 Lamp			

<sup>1</sup>Compatible with Unshunted Sockets

<sup>2</sup>Compatible with Shunted Sockets



For more helpful information  
**SCAN ME**

Gain access to our cut sheet and more by scanning the product's QR code.

# RTR T8 TLED TROFFER RETROFIT KIT

## FEATURES

- 2ft x 2ft and 2ft x 4ft available
- 2 lamp and 4 lamp T8 options (lamps not included)
- Designed for compatibility with Type B Bypass lamps
  - Consult factory for compatible options with type A and type C lamps
- Multiple reflector options
  - 95% enhanced aluminum
  - 91% white aluminum
- Multiple socket options
  - Shunted
  - Unshunted
- Pre-wired kit options for single and double ended LED tubes
- 5 year warranty
- ETL listed



envirobrite



## SUITABLE APPLICATIONS

- Offices
- Hallways
- Conference Rooms
- Multipurpose Rooms

## ORDERING GUIDE

\*Options & Accessories are not shown. Please see the cut sheet on our website at [ilp-inc.com](http://ilp-inc.com) or scan the QR code below.

SERIES	TYPE	REFLECTOR	SOCKET	OPTIONS
RTR22 - 2x2, 2 Lamp	T8	W - White Aluminum	U - Unshunted	PWS <sup>1</sup> Pre-Wired Kit Option for Single Ended LED Tubes
RTR23 - 2x2, 3 Lamp		E - Enhanced Aluminum	S - Shunted	PWD <sup>2</sup> Pre-Wired Kit Option for Double Ended LED Tubes
RTR24 - 2x2, 4 Lamp				
RTR42 - 2x4, 2 Lamp				<sup>1</sup> Compatible with Unshunted Sockets
RTR43 - 2x4, 3 Lamp				<sup>2</sup> Compatible with Shunted Sockets
RTR44 - 2x4, 4 Lamp				

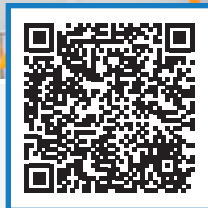

For more helpful information  
**SCAN ME**

Gain access to our cut sheet and more by scanning the product's QR code.

# NOTES

---

---

---

---

---

---

---

---

---

---

---

---

---

---

---

---

---

---

---

---

---

---

---



Visit us online at  
***ILP-INC.COM***

If you have any questions regarding products in this section, please go online to [ilp-inc.com](http://ilp-inc.com) or reach out to one of our sales reps for more information and pricing.

Published April 2022



*“YOUR NUMBER ONE SOURCE  
FOR ENERGY EFFICIENT LIGHTING”*

WWW.ILP-INC.COM | 407-478-3759  
An ILLUMUS Brand

